

Doc No	KYT5XXX SPECIFICATION	REV	PAGE	DATE
9100-0020		M	1 OF 68	2007. 07. 28.

Card Issuing Machine for Magnetic, Contact & IC Card

KYTronics Corp.,Ltd

3rd Floor, A-Dong,

Twin Town-Bldg, 703-2.

Gojan-Dong, AnSan-City,

Kyung Ki-Do, Korea

Tel : 82 - 31 - 485 - 9480

Fax : 82 - 31 - 485 - 9488

E-mail : sales@kytronics.co.kr

<http://www.kytronics.co.kr>

Doc No	KYT5XXX SPECIFICATION	REV	PAGE	DATE
9100-0020		M	2 OF 68	2007. 07. 28.

REVISION HISTORY

No	DATE	DESCRIPTION	REV	PAGE	F/W Name
1	2001.01.	Ver 2.00 Spec	A	50	
2	2001.03.07	Ver 2.01 Spec	A	58	
3	2001.04.09	'Wait Mode', 'RF Detect' Command Append	A	59	
4	2002.03.14	Precautions Append	B	60	
5	2002.09.09	Instruction Code Error Correction Write Data on track Chosen ; M32 → M33 Read data from all three tracks ; M33 → M35 Write Data from all three tracks ; M36 → M34 Take a card from Stacker and Write data to a Selected track ; M34 → M36	C	60	
6	2002.09.23	'M36', 'M37' Command Format Modified	D	60	
7	2002.09.25	Model Name Info Modified	E	60	
8	2003.02.04	Ver 2.20 Spec Function added. Secret Key Read 'Access Condition' Write Sector 0 Read / Write Sector 0 Increment / Decrement	F	63	F/W Version : 2.2 KYT510 : K122030204.bin KYT520 : K222030204.bin KYT530 : K322030204.bin KYT540 : K422030204.bin KYT550 : K522030204.bin KYT560 : K622030204.bin KYT570 : K722030204.bin
9	2003.12.20	Removed SLE Commands	G	63	
9	2004.09.21	Removed All Track Write Commands	H	59	
10	2004.12.15	Software Reset Function Added	I	59	
11	2005.03.10	IC Baud Rate Setting Function Added. Key Value Change Function Added from key Set.	J	61	
12	2005.12.06	With adding bezel, added the model.	K		
13	2006.10.31	Modified the model name information in the SPEC	L	68	
14	2007.07.28	Example of the new model name is added.(page 31)	M	68	

Doc No	KYT5XXX SPECIFICATION	REV	PAGE	DATE
9100-0020		M	3 OF 68	2007. 07. 28.

MODEL NAME INFORMATION

K Y T - 5

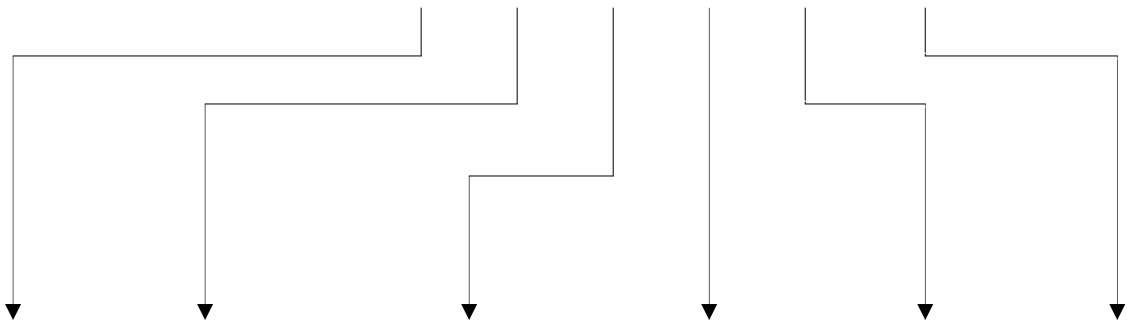

Interface	Function	MS / IC / RF	Track	Option	Capacity		Option II
T: S232C	5:ISSUING MACHINE	0 : - 1 : MS Only 2 : MS & IC-Contact 3 : MS & RF 4 : MS & IC & RF 5 : IC Only 6 : RF Only 7 : IC-Contact & RF	0 : Without Magnetic 1 : ISO 1 Track 2 : ISO 2 Track 3 : ISO 3 Track 4 : ISO 1,2 Track 5 : ISO 1,3 Track 6 : ISO 2,3 Track 7 : ISO 1,2,3 Track	0: Without bezel 1: LOW-CO Short bezel 2: HI-CO Short bezel 3: LOW-CO & Shutter 4: HI-CO & Shutter 5: Shutter	A: 0.2T B: 0.38T C: 0.5T D: 0.76T E: 0.84T F: 1.0T	G: 0.2T H: 0.38T I: 0.5T J: 0.76T K: 0.84T L: 1.0T	D: Card Drop (Without bezel)
					600 PCS	1000 PCS	

Doc No	KYT5XXX SPECIFICATION	REV	PAGE	DATE
9100-0020		M	4 OF 68	2007. 07. 28.

C O N T E N T S

Overview	5
System Block Diagram	6
Specification	8
Magnetic Card Process	10
IC Card Process	11
RF Card Process	12
Communication Interface	13
Technical Drawing	19
Command Detail	29
Error Detail	63
Precautions	68

Doc No	KYT5XXX SPECIFICATION	REV	PAGE	DATE
9100-0020		M	5 OF 68	2007. 07. 28.

OVERVIEW

KYT54XX Series is a set of card issuing machine for the magnetic, IC, and RF card in conjunction with the KYT2XXX and KYT3XXX series. This model can be used for magnetic card conforming to the ISO7816-2 standard and most of the IC cards conforming with the ISO7816-4 T=0,T=1. Additionally, this model also can be used for the RF card conforming to the MIFARE.

This model simplified the command for magnetic card, minimize the delay time occurs in the communication data processing, and improved the speed due to function to issue the all tracks at a time.

This model has the following advantages:

- 1) Remove the latency due to the user-based card exchange, by loading 600 PCS(0.76 mm card) at a time.
- 2) Use the different type of card using two stackers.

As an automatic issuing machine, this model can be used in issuing most types of credit card and debit card in financial area.

Doc No	KYT5XXX SPECIFICATION	REV	PAGE	DATE
9100-0020		M	6 OF 68	2007. 07. 28.

SYSTEM BLOCK DIAGRAM

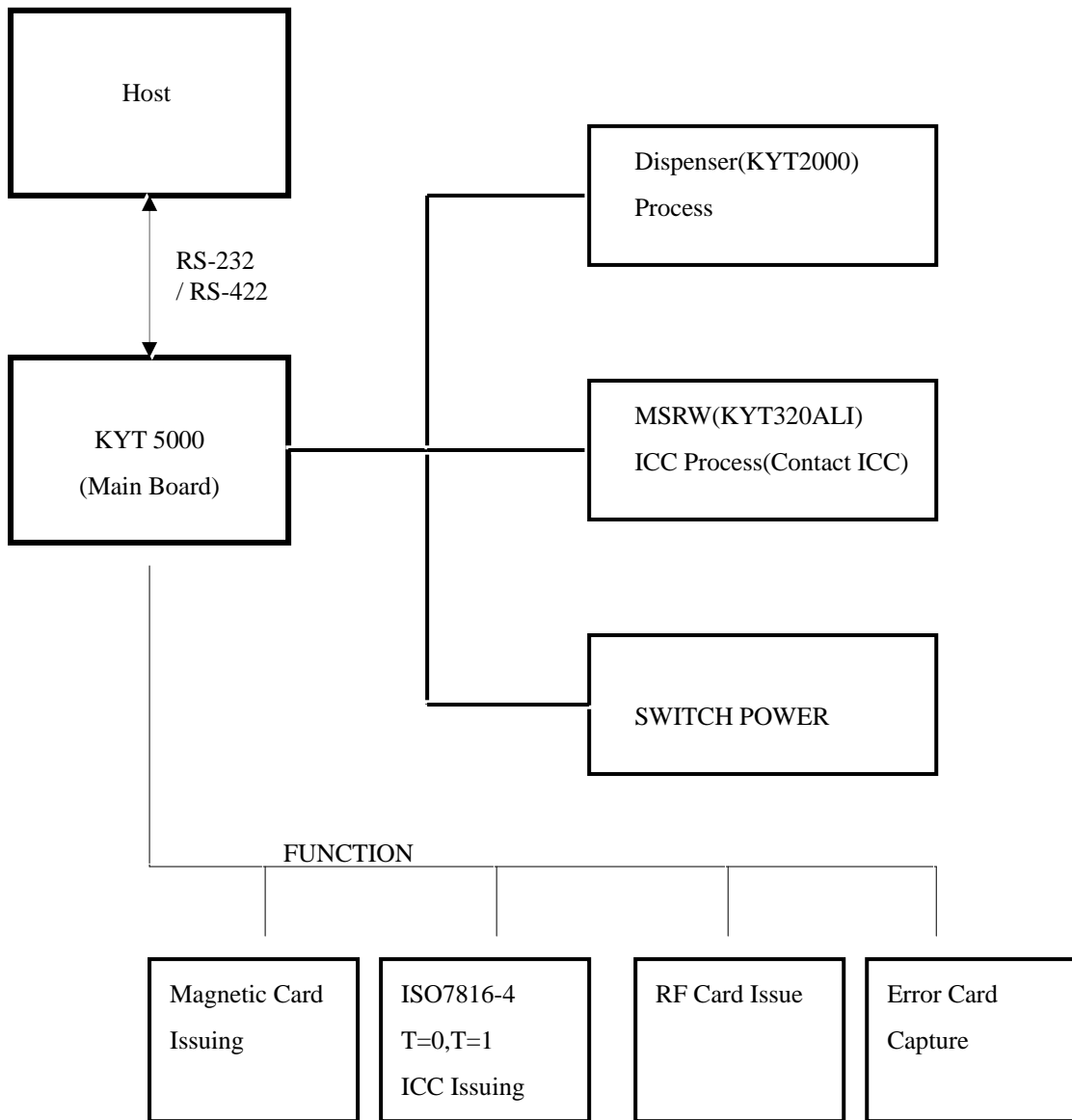

Doc No	KYT5XXX SPECIFICATION	REV	PAGE	DATE
9100-0020		M	7 OF 68	2007. 07. 28.

◆ *RS – 232 Connection*

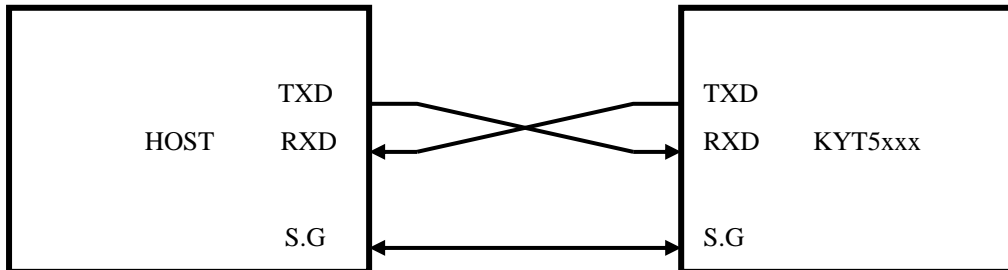

CASE 1) Part Number : RED-9S-LNA(HIROSE)

Pin No	INDEX	Remark
2	RXD	Receive
3	TXD	Transmit
5	S.G	Signal Ground

◆ *RS422 Connection*

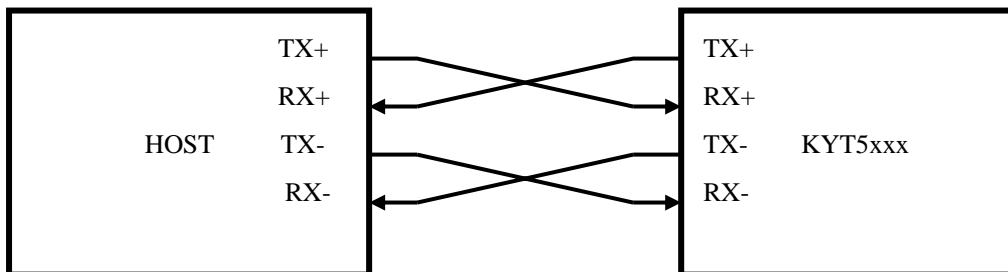

CASE 1) Part Number : RED-9S-LNA(HIROSE)

Pin No	INDEX	Remark
1	TX+	
4	RX+	
6	TX-	
8	RX-	

Doc No	KYT5XXX SPECIFICATION	REV	PAGE	DATE
9100-0020		M	8 OF 68	2007. 07. 28.

SPECIFICATIONS

◆ *basic functions*

	Spec	Remark
Dimension		
Weight		
Input power	AC 110 ~ AC 220V Free voltage	
Card Feeding Speed	510mm/Sec ±10%	

◆ *Environment Requirements*

Operating Locus : In door use only

Ambient Temperature

Storage : -20 °C to 70 °C(No functional error to be found in 12 hours after returning to normal environment)

Operating : 5 °C to 50°C (In 0°C to +5°C range, all specifications but 'Warped card' to be satisfied)

Ambient Relative Humidity

Storage : 0% to 95% RH(No functional error to be found in 12 hours after returning to normal environment)

Operating : 5 % 90% RH(No Condensation)

Vibration

: Amplitude 2mm, 10 to 50 Hz in X, Y, Z directions for 30min, 2G or less

Shock Endurance

: 30G, 11ms

Doc No	KYT5XXX SPECIFICATION	REV	PAGE	DATE
9100-0020		M	9 OF 68	2007. 07. 28.

◆ *Controller Environment*

Communication

: RS422 OR RS232C Interface

: Baud Rate – 9600 BPS

– 19200 BPS

– 38400BPS(Default)

– 57600BPS

: 8Data bit, 1 Start bit, None Parity bit, 1 Stop Bit

CPU : V25, 16MHz

RAM : 1Mbit

ROM : 512Kbit

Flash : 4Mbit(Expandable)

RTC

Doc No	KYT5XXX SPECIFICATION	REV	PAGE	DATE
9100-0020		M	10 OF 68	2007. 07. 28.

MAGNETIC CARD PROCESS

KYT-3XXX series is able to encode data on all three tracks of ISO 1,2 and 3 in one pass, which makes read / write process time shorter. It is a basic and standard option to read and write to Low – Co card.

◆ *Total processing time*

: Less than 1.2 Sec

◆ *Life and Reliability*

Life of Head : Approximately 500,000 passes
(One pass is for forward and backward movement)

Error Rate : 5/1000 cycle

◆ *Reference Standards*

: ISO 7811-1,2,3,4,5 : identification cards – Recording technique

◆ *Recording*

	ISO Track 1	ISO Track 2	ISO Track 3
BPI	210	75	210
Capacity	Max 79	Max 40	Max 107
Reading Methods	F2F		
Length	Variable		
Card thickness	Plastic : 0.76 ±0.08mm		

◆ *Warped Cards*

: This term refers to an evenly warped card having a height from the top of the convex surface to the base of the warped edge.



H : 3.00mm Max. for card jamming

Doc No	KYT5XXX SPECIFICATION	REV	PAGE	DATE
9100-0020		M	11 OF 68	2007. 07. 28.

IC CARD PROCESS

This model provides most type of IC card compliant to ISO7816 T=0,T=1 .

◆ *Processing time* : Less than 1 Sec

◆ *Number and Location of the contacts on IC Card*

: Number and location of the contacts on IC Card is specified in ISO 7816-2

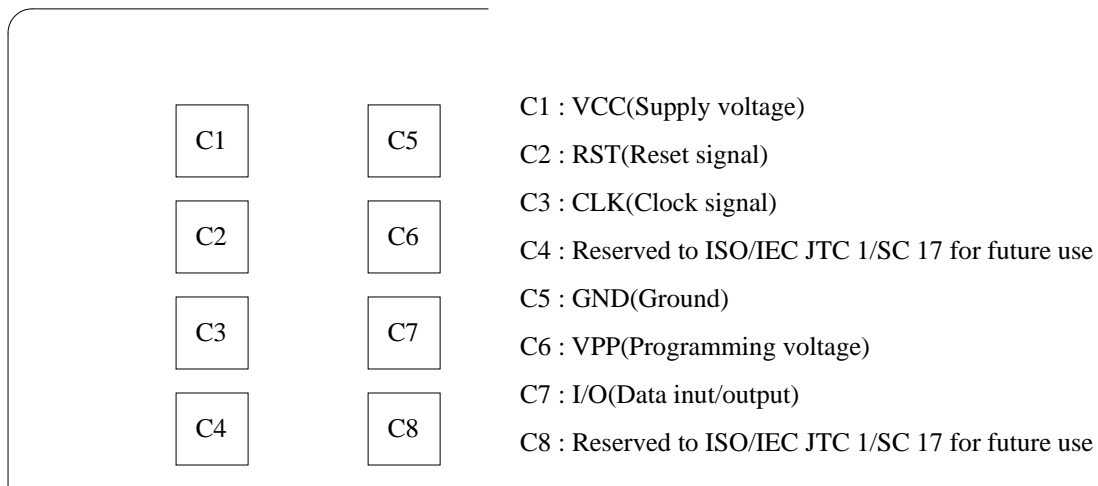

◆ *Power Consumption*

Motor Starting or Reversing	:	Less than 310mA(50mSec)
Card Feed & Reading	:	Less than 690mA
Card Feed & Writing	:	Less than 700mA
Steady state	:	Less than 180mA

◆ *Life and Reliability*

IC Contact	:	Approximately 1,000,000 passes
Error Rate	:	5/1000 cycle

Doc No	KYT5XXX SPECIFICATION	REV	PAGE	DATE
9100-0020		M	12 OF 68	2007. 07. 28.

RF CARD PROCESS

The RF module supports most of RF cards conforming with the ISO14443-3 TypeA(MIFARE Card) with 8 Kbits memory.

◆ *Processing time* : Once Block

Command	Parameter	Time (mSec)		Note
		Type	Max	
Card Read	1 Block	100		Without card moving
Card Write	1 Block	150		Without card moving, With Verify
Card Decrement	1 Block	120		Without card moving
Card Increment	1 Block	120		Without Card moving

◆ *Operating Frequency*

Operating Frequency : 13.56 MHz

Data Transfer Baud : Baud rate 106Kbaud

◆ *Operating range of the Antenna*

Guar. Operating range : All distances in the range of 0 ... 50 mm from the antenna board.

Typical operating range : 0 ... 65 mm

◆ *Power Consumption*

Supply Voltage	Operating Voltage	Operating Current	
		Type	Max
+ 5 V	+5V +10% -5%	165mA	255mA

Doc No	KYT5XXX SPECIFICATION	REV	PAGE	DATE
9100-0020		M	13 OF 68	2007. 07. 28.

COMMUNICATION INTERFACE

◆ *Communication Method*

Asynchronous, Half duplex.

Baud Rate : 9600 – 57600Bps , Default : 38400Bps

Start Bit : 1Bit

Data Length : 8Bit

Parity : None

Stop Bit : 1Bit

◆ *Communication Protocol Format*

1 *Command Frame Format.*

SOH	Null	Length	STX	CMD	DATA	ETX	BCC
1 byte	1 byte	2 byte	1 byte	3 byte	N byte	1 byte	1 byte

2 *Positive Response Frame Format*

SOH	Null	Length	STX	CMD	GOOD	0x01	DATA	ETX	BCC
1 byte	1 byte	2 byte	1 byte	3 byte	2 byte	1 byte	1 byte	1 byte	1 byte

(N byte: variable length)

3 *Negative Response Frame Format*

SOH	Null	Length	STX	CMD	E-Code	0x00	ETX	BCC
1 byte	1 byte	2 byte	1 byte	3 byte	2 byte	1 byte	1 byte	1 byte

4 *BCC (Check Sum)*

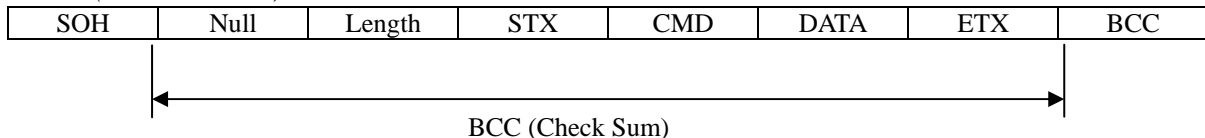

Command Frame BCC = Null ^ Length ^ STX ^ CMD ^ DATA ^ ETX.

Positive Response BCC = Null ^ Length ^ STX ^ CMD ^ GOOD ^ 0x01 ^ DATA ^ ETX.

Negative Response BCC = Null ^ Length ^ STX ^ CMD ^ E-Code ^ ETX.

Doc No	KYT5XXX SPECIFICATION	REV	PAGE	DATE
9100-0020		M	15 OF 68	2007. 07. 28.

7.3 Sequence

7.3.1 General

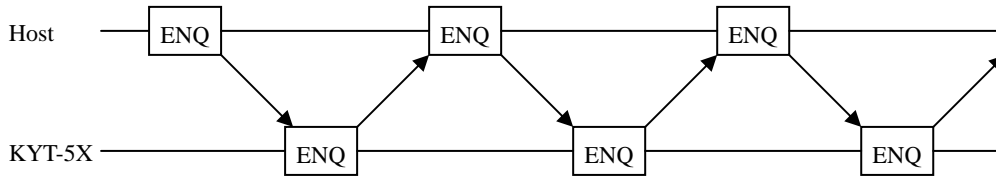
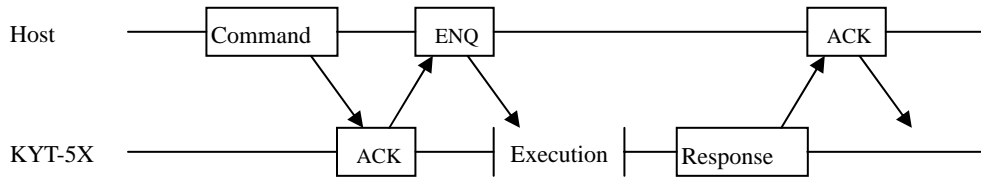

7.3.2 Event

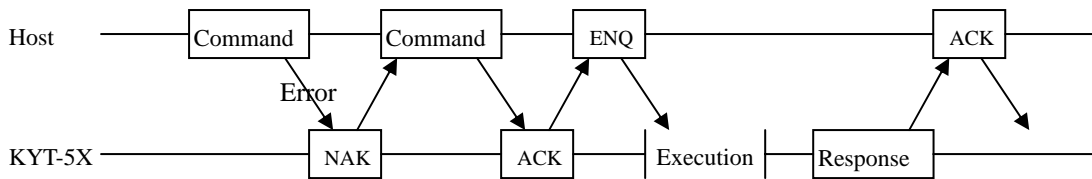

Doc No	KYT5XXX SPECIFICATION	REV	PAGE	DATE
9100-0020		M	16 OF 68	2007. 07. 28.

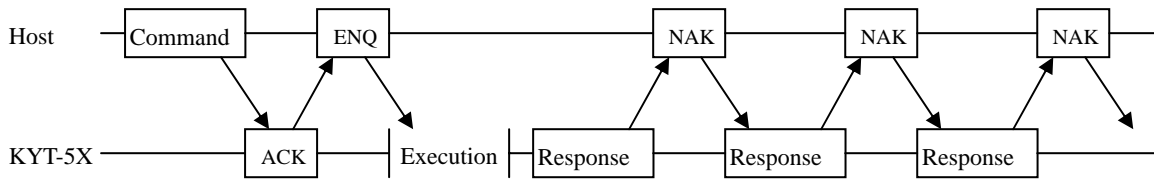
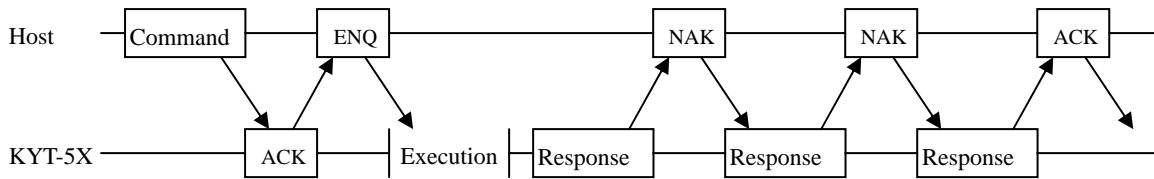
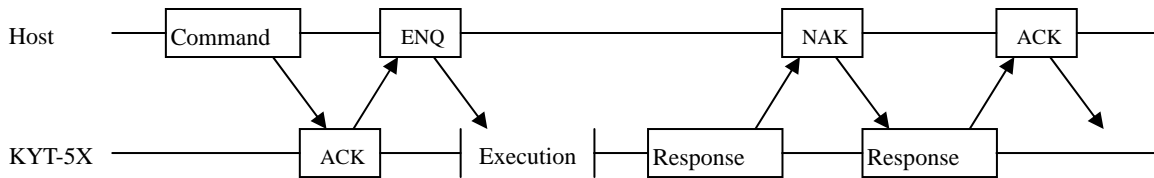
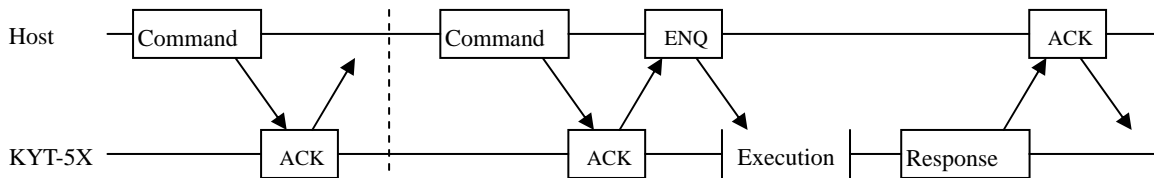
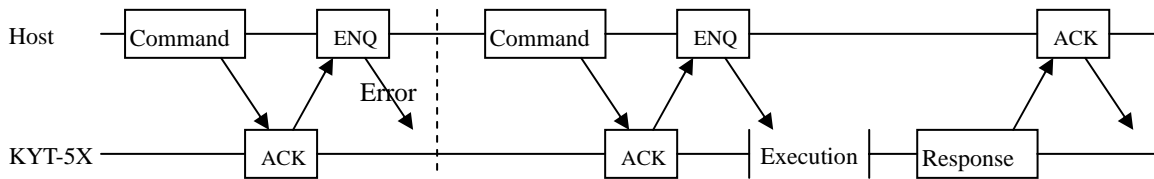
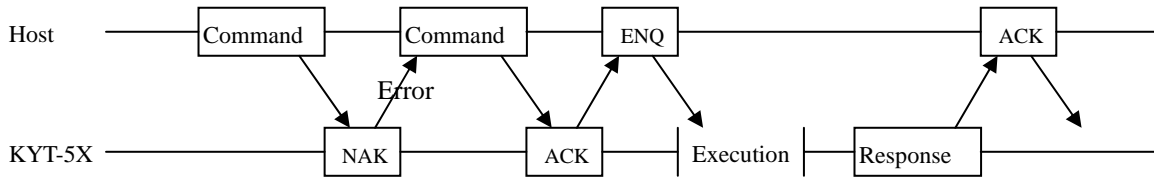

Doc No	KYT5XXX SPECIFICATION	REV	PAGE	DATE
9100-0020		M	17 OF 68	2007. 07. 28.

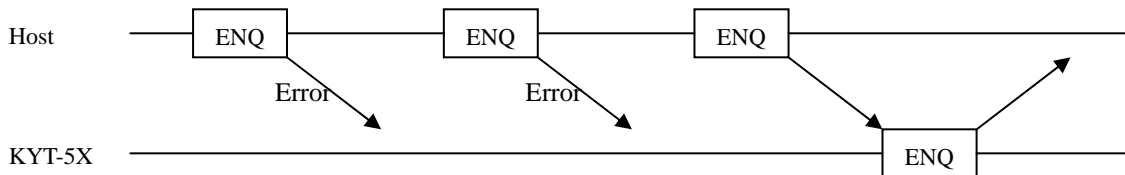
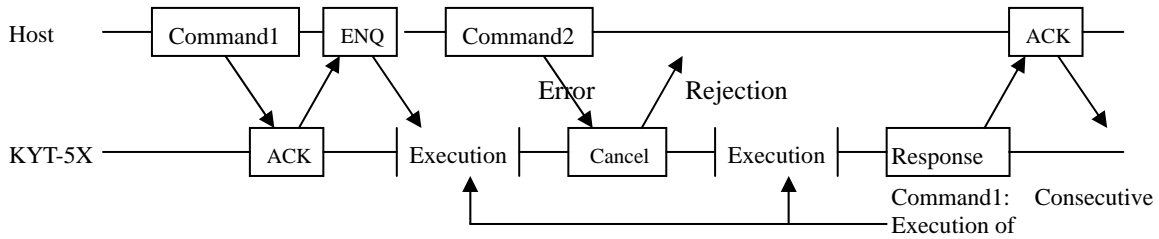
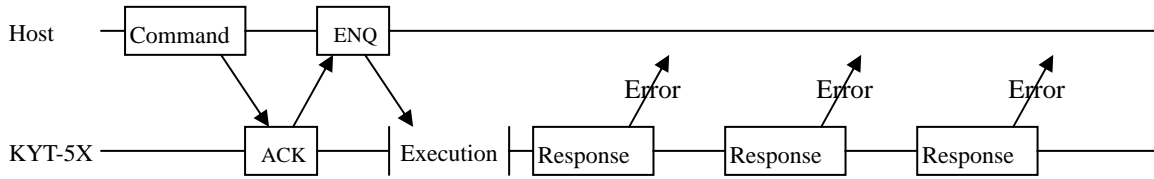
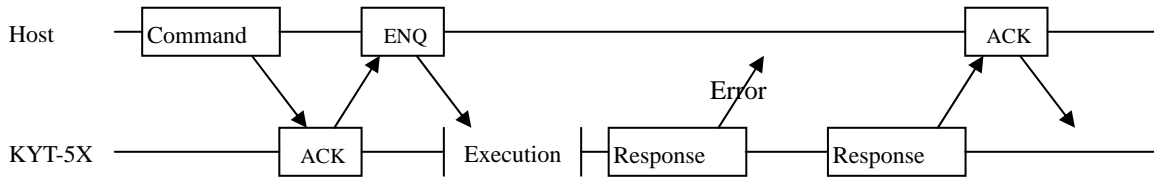

Doc No	KYT5XXX SPECIFICATION	REV	PAGE	DATE
9100-0020		M	18 OF 68	2007. 07. 28.

- When received the NAK packet consecutively.

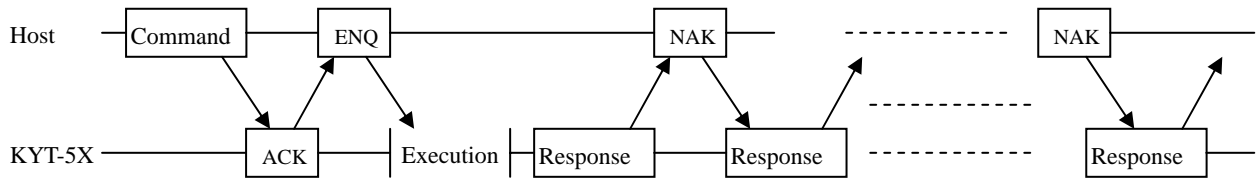

- When the Host sends the command without the ACK packet.

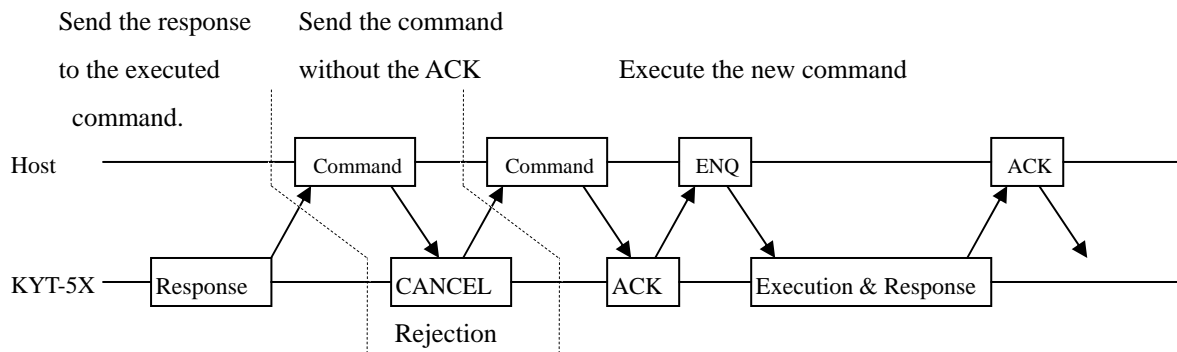

The terminal should ignore the command received before it sends the ACK packet, send the CANCEL packet. The second command will be treated as the ACK packet and executed with no ACK.

Doc No	KYT5XXX SPECIFICATION	REV	PAGE	DATE
9100-0020		M	19 OF 68	2007. 07. 28.

TECHNICAL DRAWING

<Applicable Models : KYT51XX , KYT52XX , KYT53XX , KYT54XX , KYT55XX ,
KYT57XX (Short Bezel Type) >

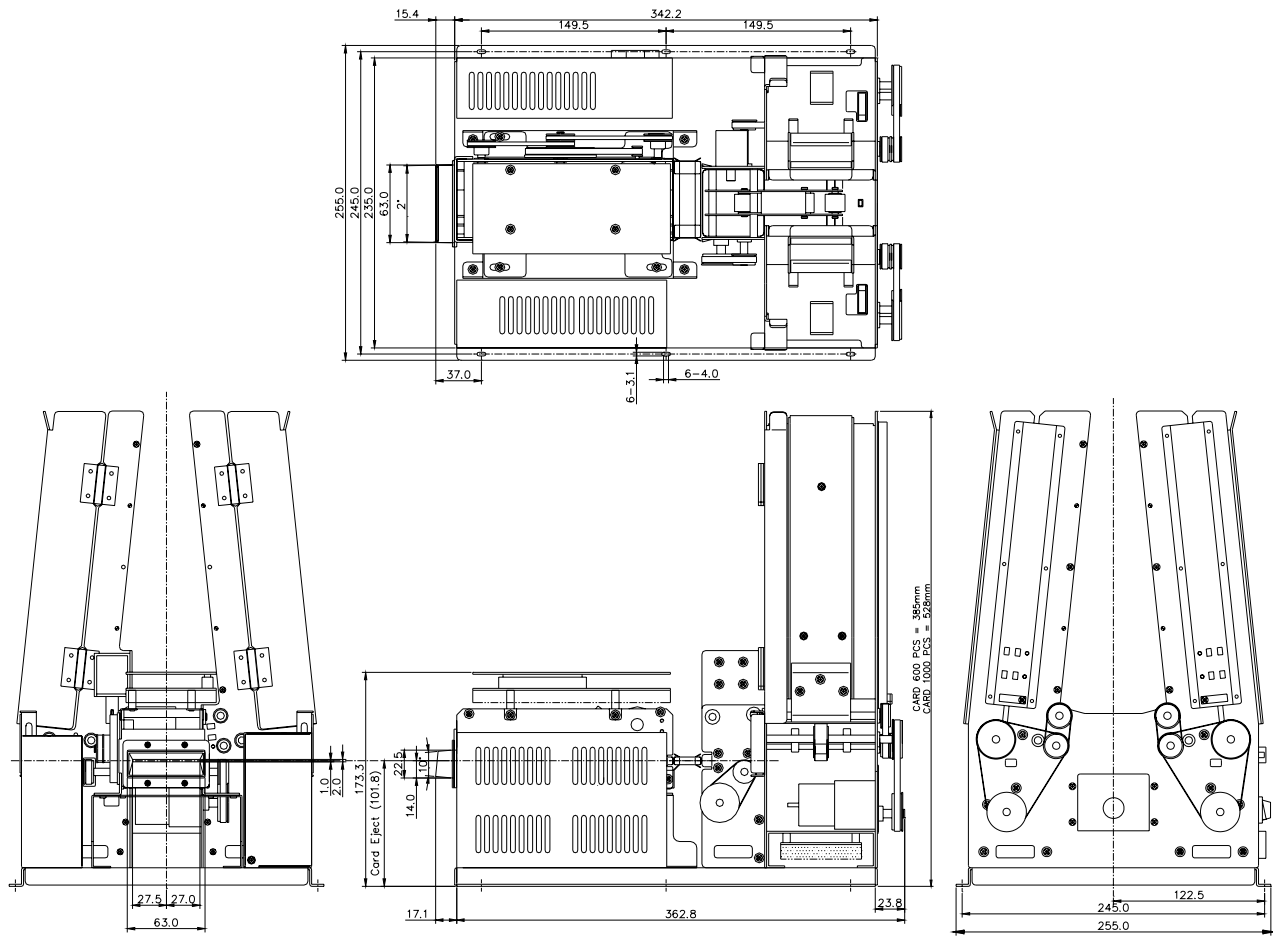

Doc No	KYT5XXX SPECIFICATION	REV	PAGE	DATE
9100-0020		M	21 OF 68	2007. 07. 28.

<Applicable Models : KYT51XX , KYT52X , KYT53XX , KYT54XX , KYT55XX ,
KYT-57XX (Drop Type)>

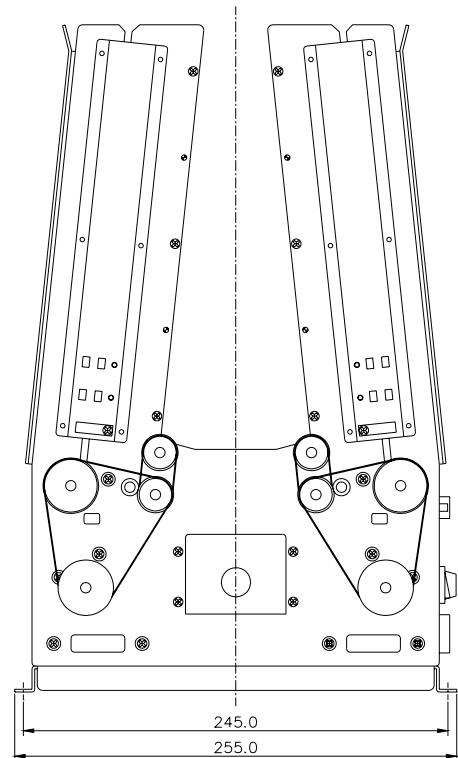
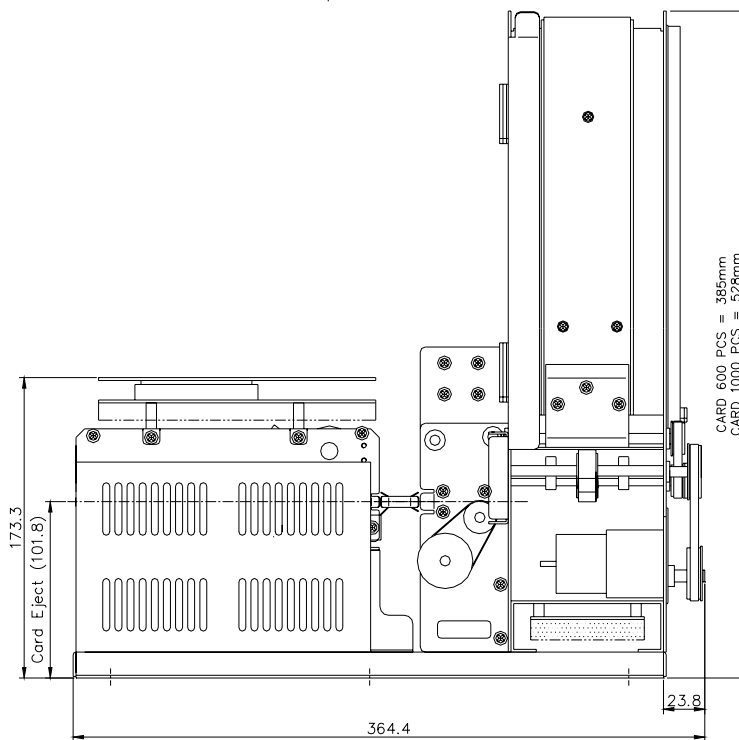
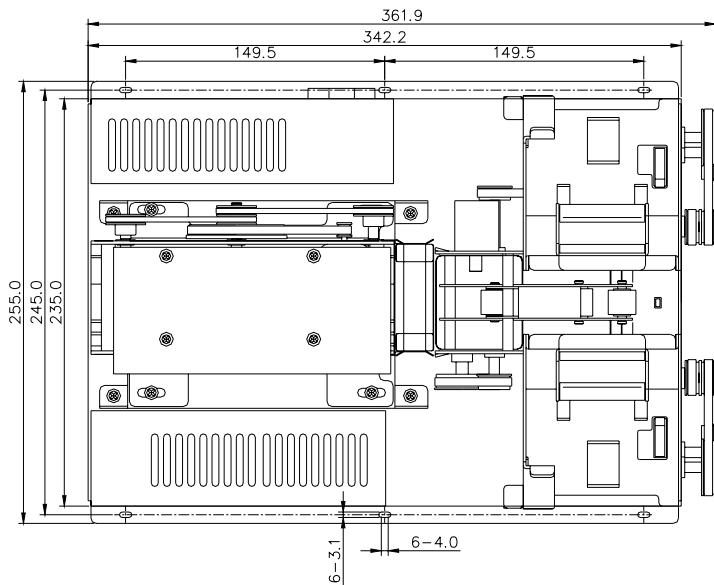

Doc No	KYT5XXX SPECIFICATION	REV	PAGE	DATE
9100-0020		M	22 OF 68	2007. 07. 28.

<Applicable Models : KYT53XX , KYT54XX , KYT-57XX (Short Bezel Type) >

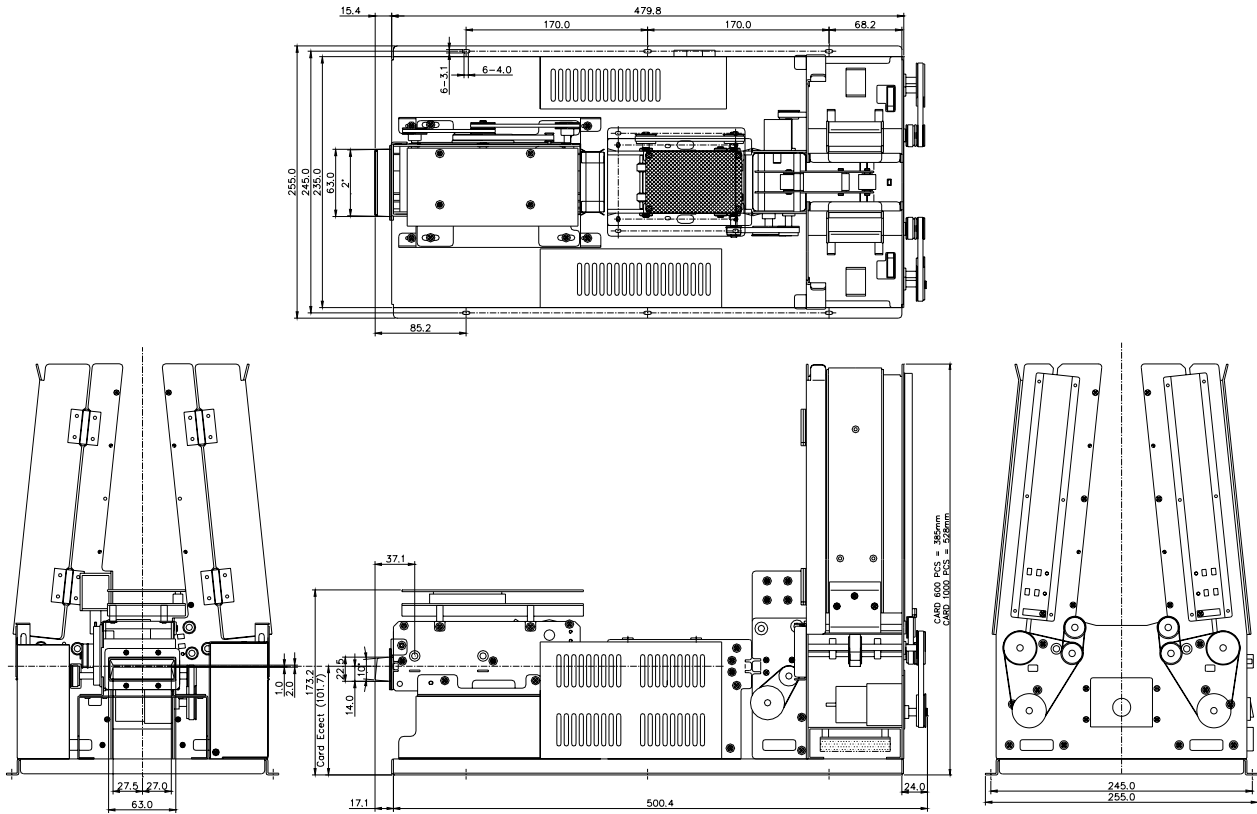

Doc No	KYT5XXX SPECIFICATION	REV	PAGE	DATE
9100-0020		M	23 OF 68	2007. 07. 28.

<Applicable Models : KYT53XX , KYT54XX , KYT-57XX (Shutter Type) >

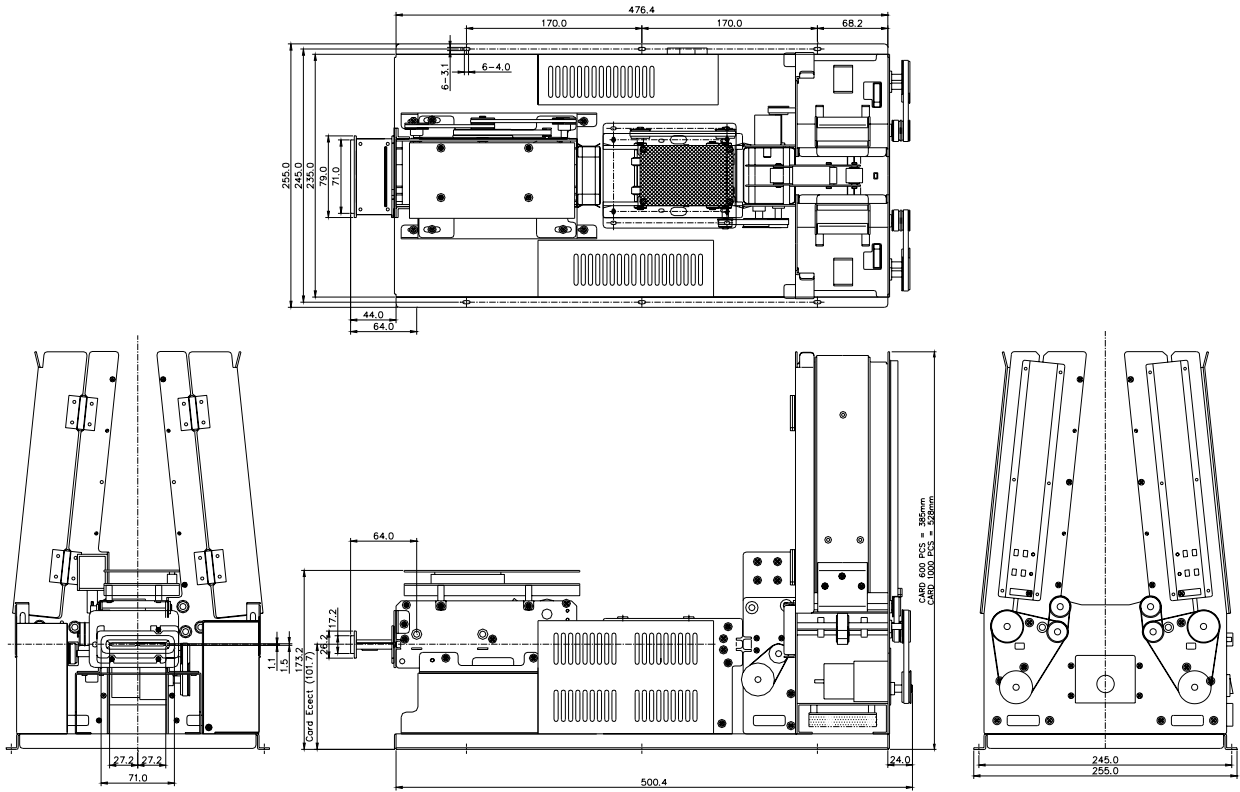

Doc No	KYT5XXX SPECIFICATION	REV	PAGE	DATE
9100-0020		M	24 OF 68	2007. 07. 28.

<Applicable Models : KYT53XX , KYT54XX , KYT57XX (Drop Type) >

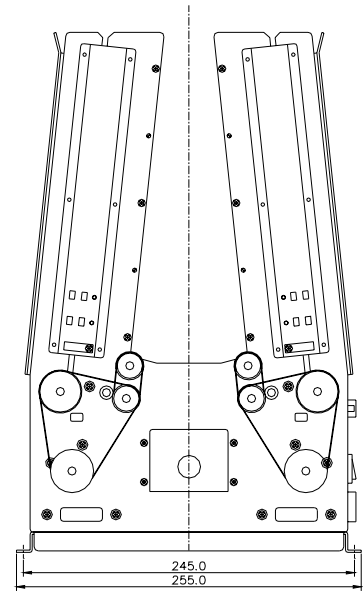
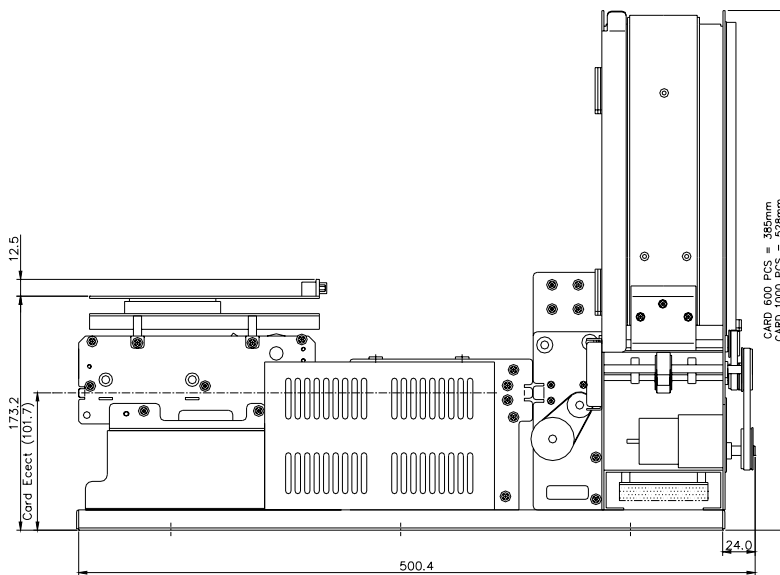
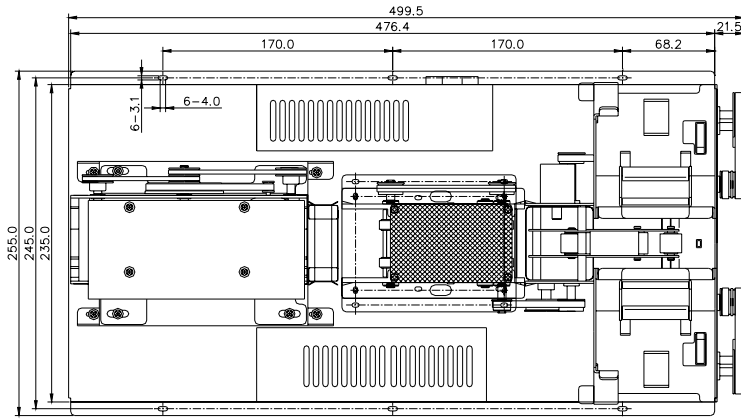

Doc No	KYT5XXX SPECIFICATION	REV	PAGE	DATE
9100-0020		M	25 OF 68	2007. 07. 28.

<Applicable Models : KYT560X (Short Bezel Type) >

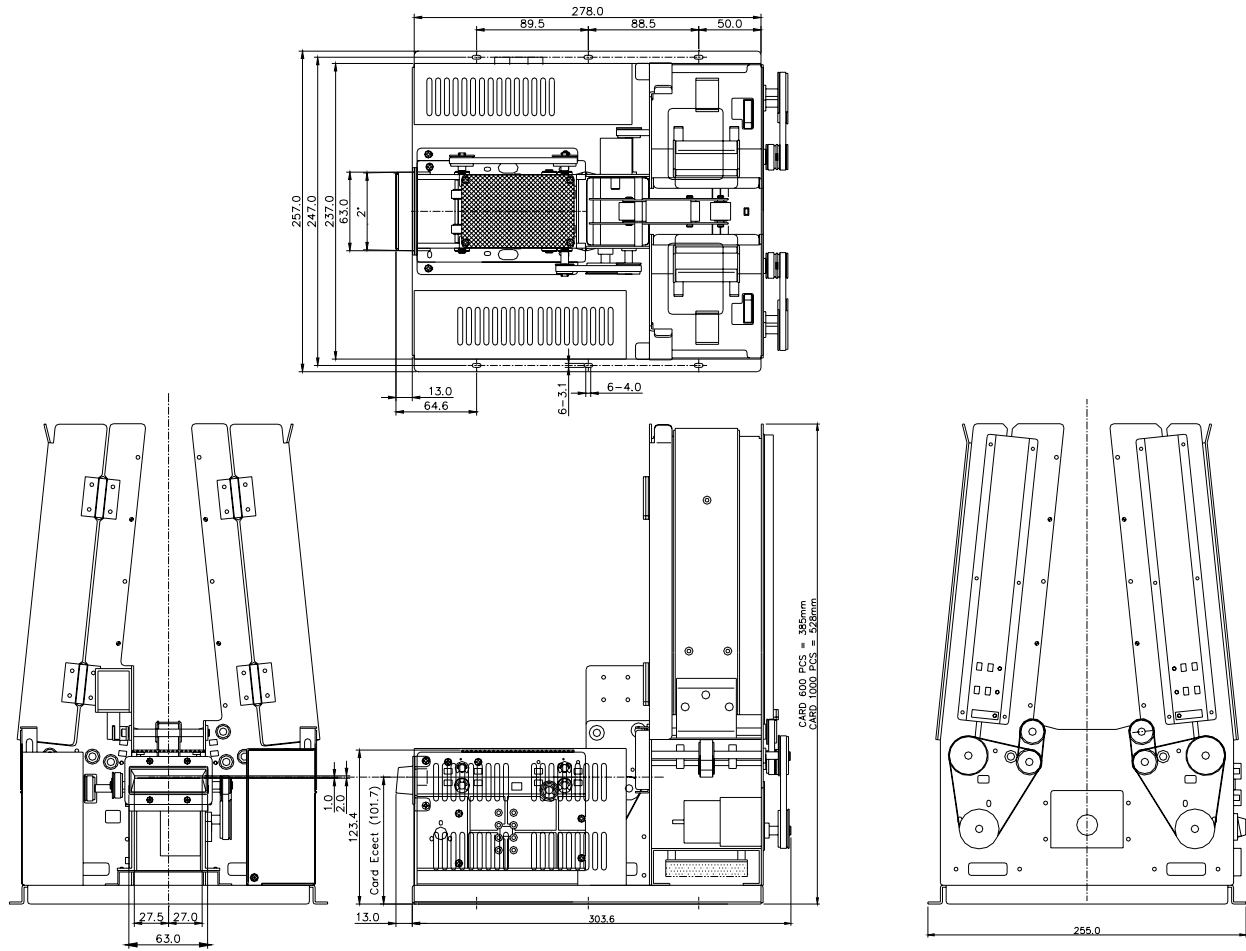

Doc No	KYT5XXX SPECIFICATION	REV	PAGE	DATE
9100-0020		M	26 OF 68	2007. 07. 28.

<Applicable Models : KYT5600 (Without Bezel & Shutter) >

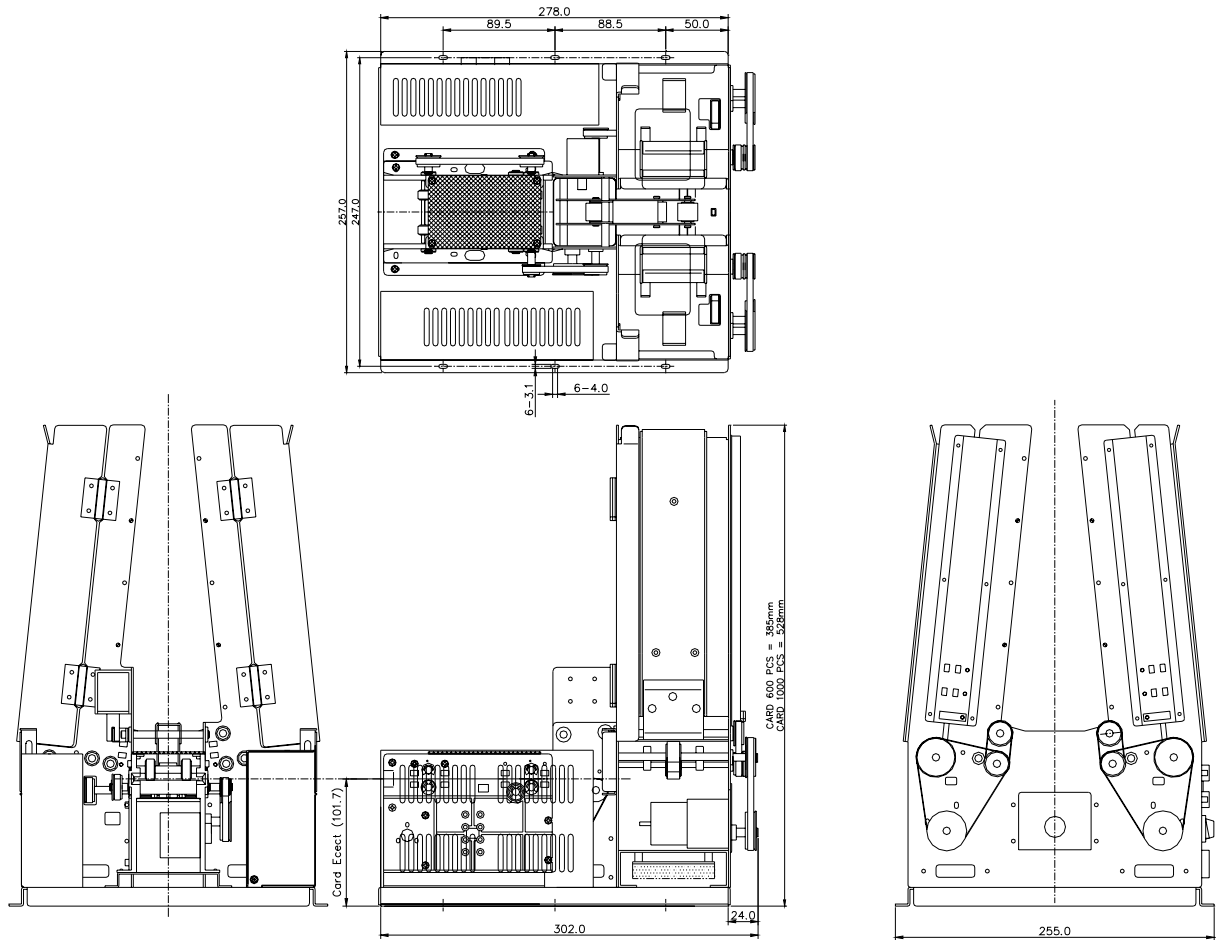

Doc No	KYT5XXX SPECIFICATION	REV	PAGE	DATE
9100-0020		M	27 OF 68	2007. 07. 28.

< Feeder Part Sensor Position >

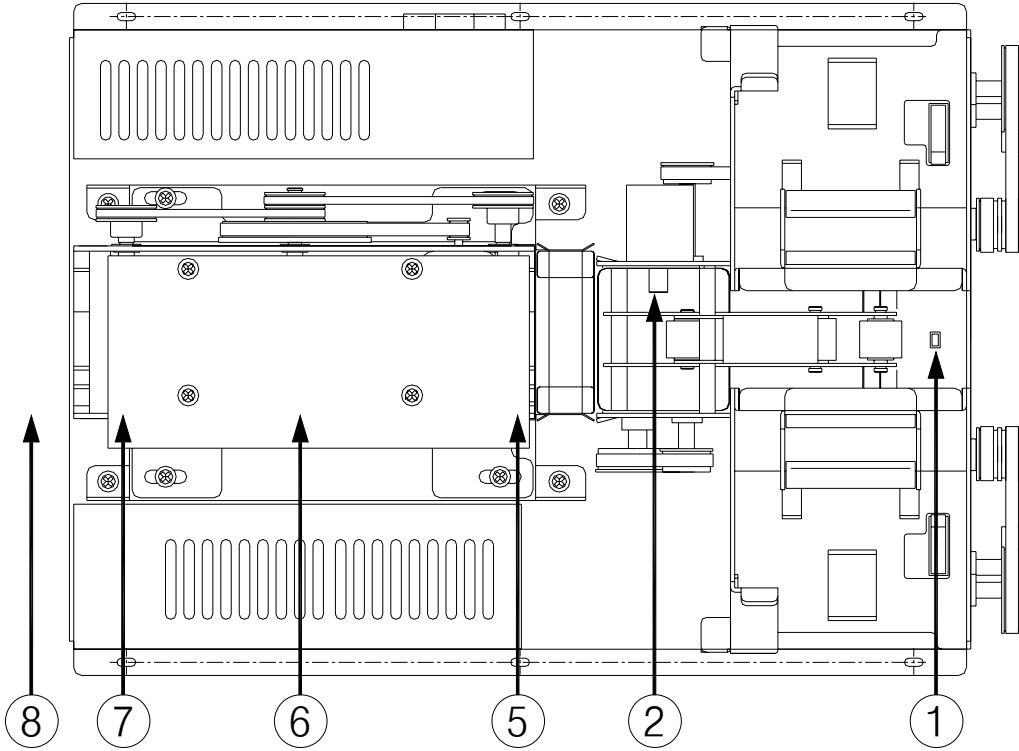

Doc No	KYT5XXX SPECIFICATION	REV	PAGE	DATE
9100-0020		M	28 OF 68	2007. 07. 28.

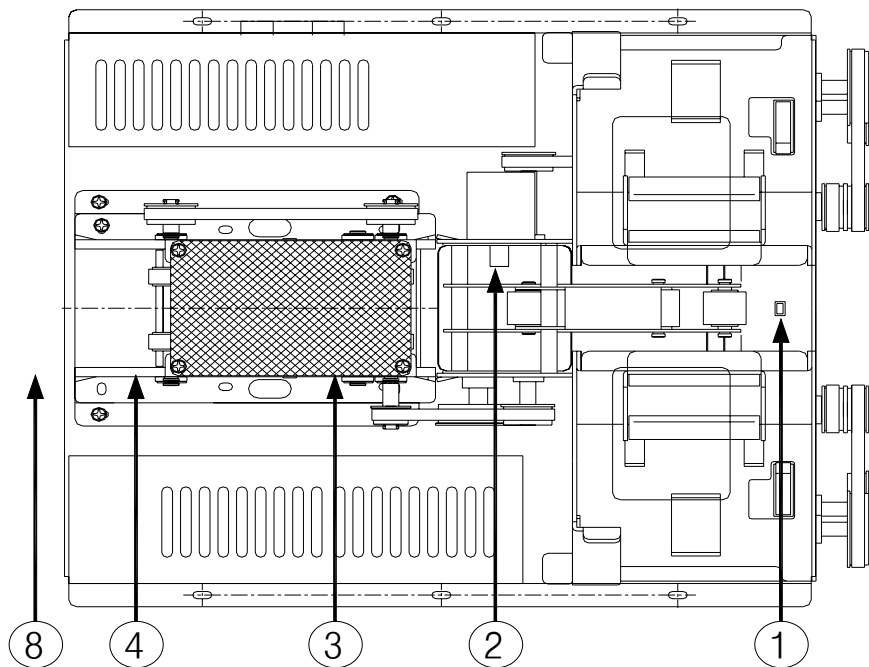
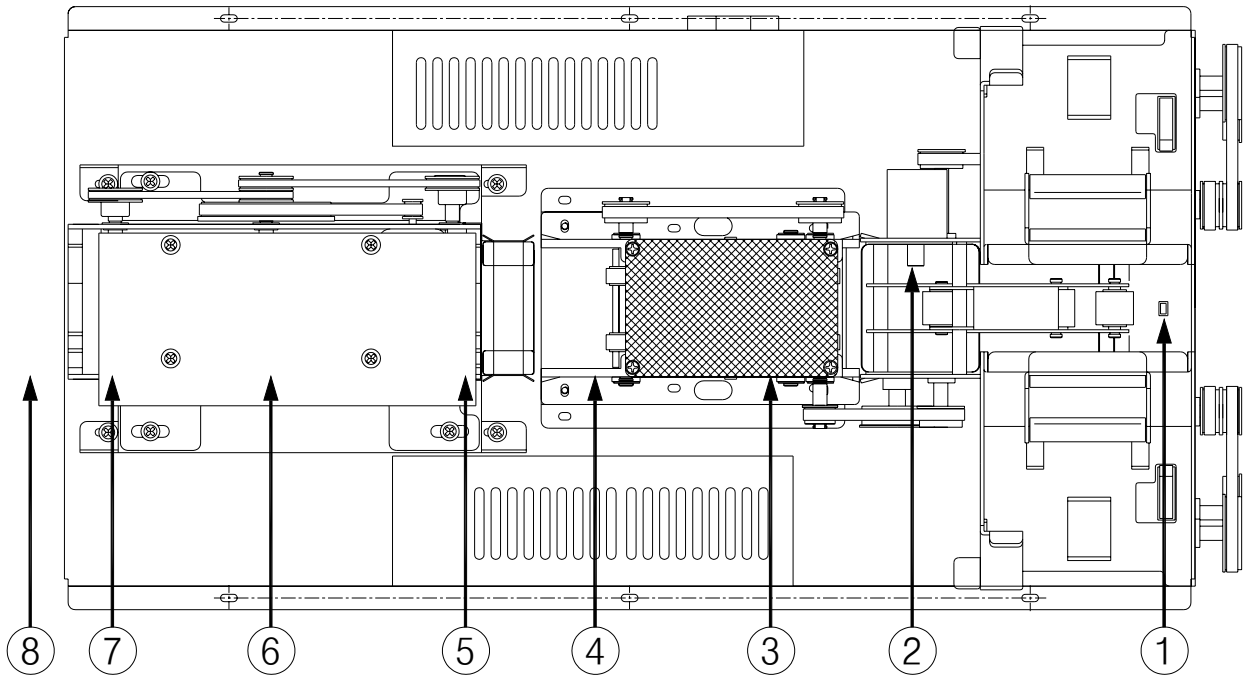

Doc No	KYT5XXX SPECIFICATION	REV	PAGE	DATE
9100-0020		M	29 OF 68	2007. 07. 28.

COMMAND DETAIL

◆ *Applicable Models*

Commands	Models	Note
COMMON	All KYT5000 Series	
MAGNETIC CARD	KYT(D)510, KYT(D)520, KYT(D)530, KYT(D)540	
IC CARD	KYT(D)520, KYT(D)540, KYT(D)550, KYT(D)570	
RF CARD	KYT(D)530, KYT(D)540, KYT560, KYT(D)570	

◆ *Command List*

	Item	Cm0	Cm1	Cm2	Detail	Note
COMMON	STATUS	'C'	'1'	'1'	Get Model	
		'C'	'1'	'2'	Get Firmware Version	
		'C'	'1'	'3'	Get Stacker	
		'C'	'1'	'4'	Get Status List	
		'C'	'1'	'5'	Get Error List	
		'C'	'1'	'6'	Get Card Position	
	SETTING_1	'C'	'2'	'1'	Set RTC IC	Check
		'C'	'2'	'2'	Set Card Eject Mode	Check
		'C'	'2'	'3'	Set Capture Time	Check
		'C'	'2'	'4'	Set Retry Count	Check
		'C'	'2'	'5'	Set Buzz On/Off Cont.	Check
		'C'	'2'	'6'	Set Baud Rate	Check
		'C'	'2'	'7'	Set Wait Mode	Check
		'C'	'2'	'8'	Set Stacker priority	Check
	MOVE	'C'	'3'	'1'	Card Move From Stacker	
		'C'	'3'	'2'	Card Move To ...	
		'C'	'3'	'3'	Card Eject	Forward
		'C'	'3'	'4'	Card Capture	Backward
	SETTING_2	C	'4'	'2'	Software Reset	
		C	'4'	'3'	IC PTS Change	
MAGNETIC CARD	MAGNETIC READ / WRITE	'M'	'3'	'1'	Magnetic Card Read	
		'M'	'3'	'3'	Magnetic Card Write	Verify
		'M'	'3'	'4'	Magnetic Card Write From Stacker	Verify
	CLEANING	'M'	'3'	'5'	Magnetic Card All Track Read	
IC CARD	IC CONTROL	'I'	'2'	'1'	IC Card Reset	
		'I'	'2'	'2'	IC Card Direct Control	
RF CARD	RF CARD READ / WRITE	'R'	'3'	'1'	RF Card Read in Block Range	
		'R'	'3'	'2'	RF Card Write in Block Range	
		'R'	'3'	'6'	RF Card Read in Sector Range	
		'R'	'3'	'7'	RF Card Write in Sector Range	
	BALANCE	'R'	'4'	'1'	Balance Increment	
		'R'	'4'	'2'	Balance Decrement	
	SECRET KEY CHANGE	'R'	'5'	'1'	Change 'Secret Key' to other Key	
		'R'	'5'	'2'	Change 'Secret Key' to all the same Key value	
		'R'	'5'	'3'	Select 'Secret Key Index'	
		'R'	'5'	'4'	Change 'RF Card Secret Key' to other Key	
	RF DETECT	'R'	'5'	'5'	Key Set and Change 'Secret Key' to other Key	
		'R'	'5'	'6'	Key Set and Change 'Secret Key' to all the same Key value	
		'R'	'6'	'1'	Check RF card in antenna area	

Doc No	KYT5XXX SPECIFICATION	REV	PAGE	DATE
9100-0020		M	30 OF 68	2007. 07. 28.

◆ *Common*

These are the command set that all the KYT5000 Series use. These commands include the terminal setting and the card movement related commands.

The 'STATUS' commands provide the function to check the current terminal status and the errors occurred during the command execution.

The 'SETTING' commands consist of commands for setting the terminal and these commands is easy to use because the same command can use for both setting and checking the terminal.

The 'MOVE' commands consist of commands used commonly like the card eject and capture command.

Commands Set:

Item	Cm0	Cm1	Cm2	Detail	Note
STATUS	'C'	'1'	'1'	Get Model	
	'C'	'1'	'2'	Get Firmware Version	
	'C'	'1'	'3'	Get Stacker	
	'C'	'1'	'4'	Get Status List	
	'C'	'1'	'5'	Get Error List	
SETTING	'C'	'2'	'1'	Set RTC IC	Check
	'C'	'2'	'2'	Set Card Eject Mode	Check
	'C'	'2'	'3'	Set Capture Time	Check
	'C'	'2'	'4'	Set Retry Count	Check
	'C'	'2'	'5'	Set Buzz On/Off Cont.	Check
	'C'	'2'	'6'	Set Baud Rate	Check
	'C'	'2'	'7'	Set Wait Mode	Check
	'C'	'2'	'8'	Set Stacker priority	Check
MOVE	'C'	'3'	'1'	Card Move In Stacker	
	'C'	'3'	'2'	Card Move To ...	
	'C'	'3'	'3'	Card Eject	Forward
	'C'	'3'	'4'	Card Capture	Backward
SETTING	'C'	'4'	'2'	S/W Reset	

Doc No	KYT5XXX SPECIFICATION	REV	PAGE	DATE
9100-0020		M	31 OF 68	2007. 07. 28.

1 STATUS / SETTING

1.1 “C11” : It is to check out Model number of KYT-5000.

☞ Command Format

SOH	Null	Length	STX	“C11”	ETX	Bcc
-----	------	--------	-----	-------	-----	-----

☞ Positive Response Format

SOH	Null	Length	STX	“C11”	GOOD	0x01	DATA	ETX	Bcc
-----	------	--------	-----	-------	------	------	------	-----	-----

☞ Negative Response Format

SOH	Null	Length	STX	“C11”	E-Code	0x00	ETX	Bcc
-----	------	--------	-----	-------	--------	------	-----	-----

☞ Response Data Structure

Model No
1Byte (Hex)

☞ Data Variable

<Model No>

Code	Detail	Code	Detail	Code	Detail	Code	Detail
0x01	KYT510	0x05	KYT550	0x10	KYD510	0x50	KYD550
0x02	KYT520	0x06	KYT560	0x20	KYD520	0x60	KYD560
0x03	KYT530	0x07	KYT570	0x30	KYD530	0x70	KYD570
0x04	KYT540			0x40	KYD540		

<NOTE> 1. Model name “KYT510” is translated as new model name “KYT51XXX”. And model name “KYD510” is translated as new model name “KYT51XXXD”

1.2 “C12” : It is to check out Firmware Version of KYT-5000

☞ Command Format

SOH	Null	Length	STX	“C12”	ETX	Bcc
-----	------	--------	-----	-------	-----	-----

☞ Positive Response Format

SOH	Null	Length	STX	“C12”	GOOD	0x01	DATA	ETX	Bcc
-----	------	--------	-----	-------	------	------	------	-----	-----

☞ Negative Response Format

SOH	Null	Length	STX	“C12”	E-Code	0x00	ETX	Bcc
-----	------	--------	-----	-------	--------	------	-----	-----

☞ Response Data Structure

High Version	Low Version
1Byte (BCD)	1Byte (BCD)

☞ Note

If ‘High Version’ is 0x03 and ‘Low Version’ is 0x75, it tells that Firmware Version is Ver “3.75”

Doc No	KYT5XXX SPECIFICATION	REV	PAGE	DATE
9100-0020		M	32 OF 68	2007. 07. 28.

1.3 “C13” : It is check out status of Stacker of KYT-5000

☞ Command Format

SOH	Null	Length	STX	“C13”	ETX	Bcc
-----	------	--------	-----	-------	-----	-----

☞ Positive Response Format

SOH	Null	Length	STX	“C13”	GOOD	0x01	DATA	ETX	Bcc
-----	------	--------	-----	-------	------	------	------	-----	-----

☞ Negative Response Format

SOH	Null	Length	STX	“C13”	E-Code	0x00	ETX	Bcc
-----	------	--------	-----	-------	--------	------	-----	-----

☞ Response Data Structure

Stacker 1	Stacker 2
1Byte (Hex)	1Byte (Hex)

☞ Data Variable

<Stacker1>

Code	Status
0x01	Stacker #1 Good
0x02	Stacker #1 Warning
0x03	Stacker #1 Empty

<Stacker2>

Code	Status
0x01	Stacker #2 Good
0x02	Stacker #2 Warning
0x03	Stacker #2 Empty

☞ Note

Stacker Status	Detail
‘Stacker Good’	Too many cards loading ¹⁾
‘Stacker Warning’	Too few cards loading ¹⁾
‘Stacker Empty’	No cards in stacker

1) The stacker status is detected by the sensor behind the stacker. The number of cards can be changed.

1.4 “C14” : It is to check out current Status of KYT-5000

☞ Command Format

SOH	Null	Length	STX	“C14”	ETX	Bcc
-----	------	--------	-----	-------	-----	-----

☞ Positive Response Format

SOH	Null	HL	Length	“C14”	GOOD	0x01	DATA	ETX	Bcc
-----	------	----	--------	-------	------	------	------	-----	-----

☞ Negative Response Format

SOH	Null	Length	STX	“C14”	E-Code	0x00	ETX	Bcc
-----	------	--------	-----	-------	--------	------	-----	-----

☞ Response Data Structure

Error Code (1)	---	Error Code (N)
High Byte	Low Byte	
2Byte		

☞ Note

You can identify the stacker status, motor status, card status (jamming) and communication status through the Error Code in the response data structure.

Doc No	KYT5XXX SPECIFICATION	REV	PAGE	DATE
9100-0020		M	33 OF 68	2007. 07. 28.

1.5 “C15” : It is to check out error while Command is being executed.

☞ Command Format

SOH	Null	Length	STX	“C15”	ETX	Bcc
-----	------	--------	-----	-------	-----	-----

☞ Positive Response Format

SOH	Null	Length	STX	“C15”	GOOD	0x01	DATA	ETX	Bcc
-----	------	--------	-----	-------	------	------	------	-----	-----

☞ Negative Response Format

SOH	Null	Length	STX	“C15”	E-Code	0x00	ETX	Bcc
-----	------	--------	-----	-------	--------	------	-----	-----

☞ Response Data Structure

Error Time (1)	Error Code (1)	---	Error Time (N)	Error Code (N)
7Byte (BCD)	2Byte (Hex)	---	7Byte (BCD)	2Byte (Hex)

High Year	Low Year	Month	Day	Hour	Minute	Second
1Byte	1Byte	1Byte	1Byte	1Byte	1Byte	1Byte

High Byte	Low Byte
1Byte	1Byte

☞ Note

This command is only correspond to the error occurred during command execution. The time when an error is occurred is represented to the BCD, while the error code to the HEX.

1.6 “C16” : It is to check out current card position of KYT-5000

☞ Command Format

SOH	Null	Length	STX	“C16”	ETX	Bcc
-----	------	--------	-----	-------	-----	-----

☞ Positive Response Format

SOH	Null	Length	STX	“C16”	GOOD	0x01	DATA	ETX	Bcc
-----	------	--------	-----	-------	------	------	------	-----	-----

☞ Negative Response Format

SOH	Null	Length	STX	“C16”	E-Code	0x00	ETX	Bcc
-----	------	--------	-----	-------	--------	------	-----	-----

☞ Response Data Structure

Card Position
1Byte (Hex)

<Card Position> Refer to page 27.

Number	Code	Sensor
1	0x01	SEN1
2	0x02	SEN2
3	0x04	SEN3
4	0x08	SEN4
5	0x10	SEN5
6	0x20	SEN6
7	0x40	SEN7
8	0x80	SEN8

Doc No	KYT5XXX SPECIFICATION	REV	PAGE	DATE
9100-0020		M	34 OF 68	2007. 07. 28.

2 SETTING

2.1 “C21” : It is to set or to check ‘RTC IC’.

☞ Command Format

SOH	Null	Length	STX	“C21”	DATA	ETX	Bcc
-----	------	--------	-----	-------	------	-----	-----

☞ Command Data Structure

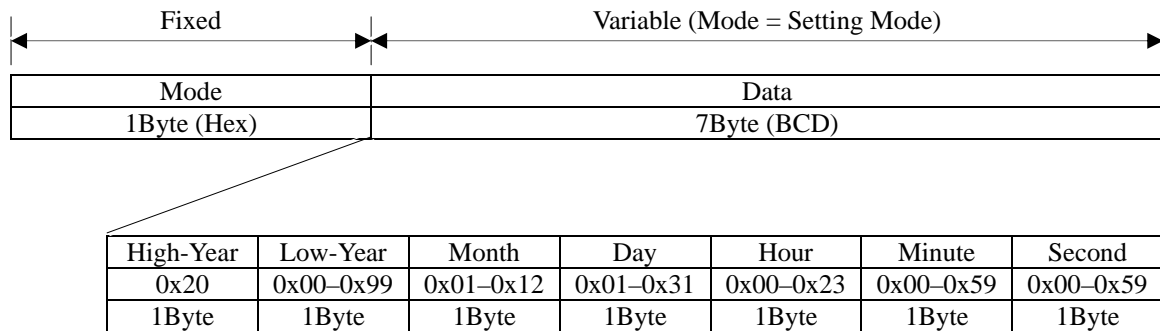

☞ Positive Response Format

SOH	Null	Length	STX	“C21”	GOOD	0x01	DATA	ETX	Bcc
-----	------	--------	-----	-------	------	------	------	-----	-----

☞ Negative Response Format

SOH	Null	Length	STX	“C21”	E-Code	0x00	ETX	Bcc
-----	------	--------	-----	-------	--------	------	-----	-----

☞ Response Data Structure

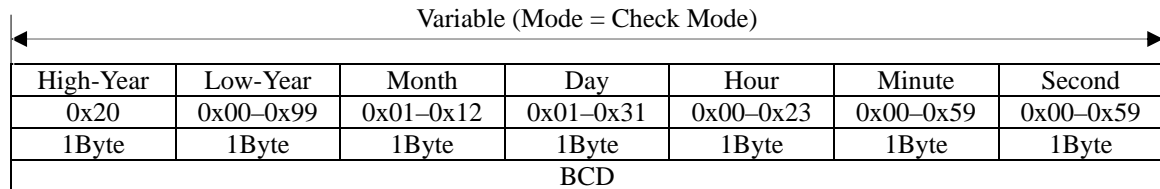

☞ Data Variable

<Mode>

Code	Mode	Detail
0x01	‘Setting Mode’	Set ‘RTC IC’
0x02	‘Check Mode’	Check ‘RTC IC’

☞ Note

‘Day’ is changeable due to the value of ‘Month’.

Doc No	KYT5XXX SPECIFICATION	REV	PAGE	DATE
9100-0020		M	35 OF 68	2007. 07. 28.

2.2 “C22” : It is to set or to check ‘Eject Mode’.

Command Format

SOH	Null	Length	STX	“C22”	DATA	ETX	Bcc
-----	------	--------	-----	-------	------	-----	-----

Command Data Structure

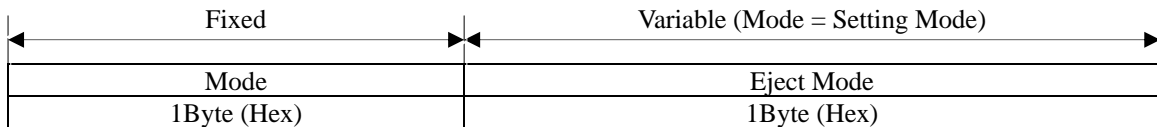

Positive Response Format

SOH	Null	Length	STX	“C22”	GOOD	0x01	DATA	ETX	Bcc
-----	------	--------	-----	-------	------	------	------	-----	-----

Negative Response Format

SOH	Null	Length	STX	“C22”	E-Code	0x00	ETX	Bcc
-----	------	--------	-----	-------	--------	------	-----	-----

Response Data Structure

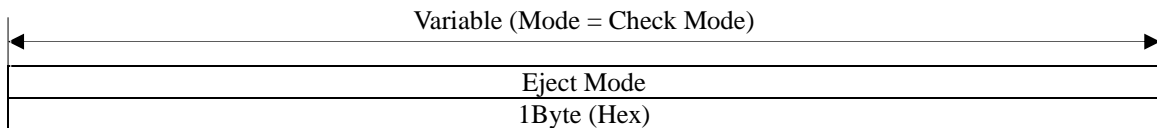

Data Variable

<Mode>

Code	Mode	Detail
0x01	‘Setting Mode’	Set ‘Eject Mode’
0x02	‘Check Mode’	Check ‘Eject Mode’

<Eject Mode>

Code	Mode	Detail	Note
0x01	‘Hold Mode’	Set ‘Hold Mode’	
0x02	‘Drop Mode’	Set ‘Drop Mode’	Default

Note

‘Hold / Drop’ Mode

‘Hold/Drop’ mode is related to the card ejection. In Hold mode, if the card eject command is executed, the terminal operates in a way that a user pulls it out, while the terminal keeps the card in place. In Drop mode, if the same command is executed, the terminal ejects the card completely. In case of the Hold mode, refer to the function ‘Capture Time’.

Doc No	KYT5XXX SPECIFICATION	REV	PAGE	DATE
9100-0020		M	36 OF 68	2007. 07. 28.

2.3 “C23” : It is to set or to check ‘Capture Time’.

☞ Command Format

SOH	Null	Length	STX	“C23”	DATA	ETX	Bcc
-----	------	--------	-----	-------	------	-----	-----

☞ Command Data Structure

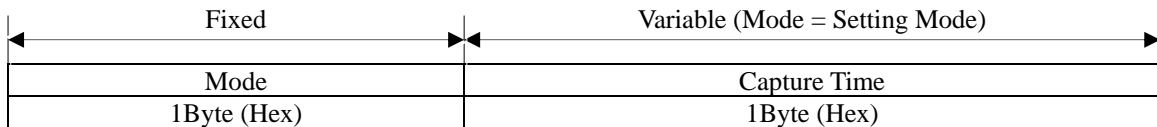

☞ Positive Response Format

SOH	Null	Length	STX	“C23”	GOOD	0x01	DATA	ETX	Bcc
-----	------	--------	-----	-------	------	------	------	-----	-----

☞ Negative Response Format

SOH	Null	Length	STX	“C23”	E-Code	0x00	ETX	Bcc
-----	------	--------	-----	-------	--------	------	-----	-----

☞ Response Data Structure

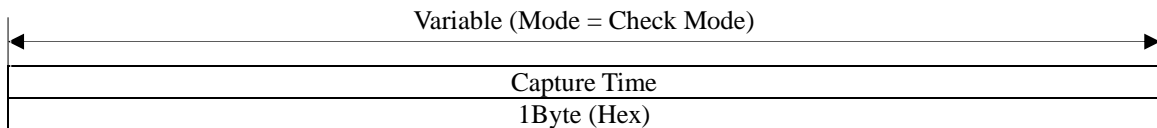

☞ Data Variable

<Mode>

Code	Mode	Detail
0x01	‘Setting Mode’	Set ‘Capture Time’
0x02	‘Check Mode’	Check ‘Capture Time’

<Capture Time>

Code	Setting	Detail	Note
0x00	NON	‘Capture Time’ not set	
0x01	10Sec	‘Capture Time’ to be set 10 seconds	
0x02	20Sec	‘Capture Time’ to be set 20 seconds	Default
0x03	30Sec	‘Capture Time’ to be set 30 seconds	
0x04	40Sec	‘Capture Time’ to be set 40 seconds	
0x05	50Sec	‘Capture Time’ to be set 50 seconds	
0x06	60Sec	‘Capture Time’ to be set 60 seconds	

☞ Note

‘Capture Time’ Function

In Hold mode, if user doesn’t pull out the card from the terminal in ‘Capture Time’ period, it gets back the card automatically.

Doc No	KYT5XXX SPECIFICATION	REV	PAGE	DATE
9100-0020		M	37 OF 68	2007. 07. 28.

2.4 “C24” : It is to set or to check ‘Retry Count’.

☞ Command Format

SOH	Null	Length	STX	“C24”	DATA	ETX	Bcc
-----	------	--------	-----	-------	------	-----	-----

☞ Command Data Structure

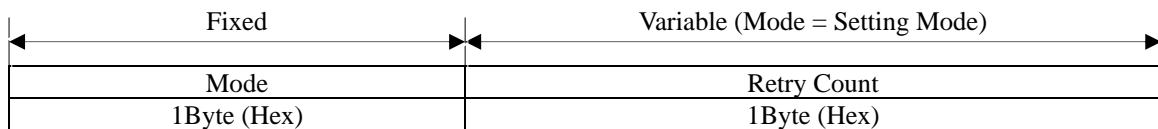

☞ Positive Response Format

SOH	Null	Length	STX	“C24”	GOOD	0x01	DATA	ETX	Bcc
-----	------	--------	-----	-------	------	------	------	-----	-----

☞ Negative Response Format

SOH	Null	Length	STX	“C24”	E-Code	0x00	ETX	Bcc
-----	------	--------	-----	-------	--------	------	-----	-----

☞ Response Data Structure

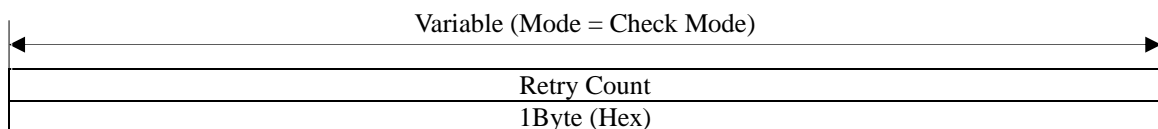

☞ Data Variable

<Mode>

Code	Mode	Detail
0x01	‘Setting Mode’	Set ‘Retry Count’
0x02	‘Check Mode’	Check ‘Retry Count’

<Retry Count>

Code	Setting	Detail	Note
0x00	NON	Do not retry	
0x01	Once	Execute the instruction again.	
0x02	Twice	Retry it twice	
0x03	Three times	Retry it three times	Default

Doc No	KYT5XXX SPECIFICATION	REV	PAGE	DATE
9100-0020		M	38 OF 68	2007. 07. 28.

2.5 “C25” : It is to set or to check ‘Buzz Control’.

☞ Command Format

SOH	Null	Length	STX	“C25”	DATA	ETX	Bcc
-----	------	--------	-----	-------	------	-----	-----

☞ Command Data Structure

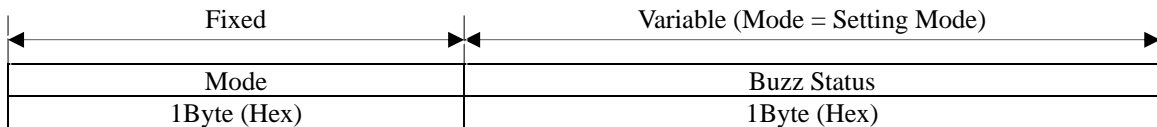

☞ Positive Response Format

SOH	Null	Length	STX	“C25”	GOOD	0x01	DATA	ETX	Bcc
-----	------	--------	-----	-------	------	------	------	-----	-----

☞ Negative Response Format

SOH	Null	Length	STX	“C25”	E-Code	0x00	ETX	Bcc
-----	------	--------	-----	-------	--------	------	-----	-----

☞ Response Data Structure

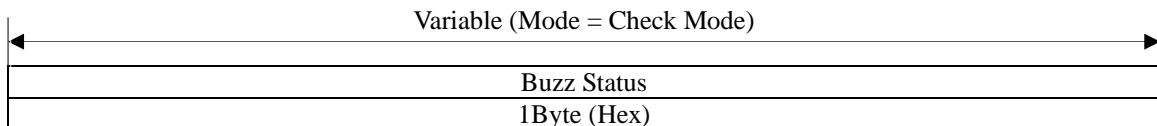

☞ Data Variable

<Mode>

Code	Mode	Detail
0x01	‘Setting Mode’	Set ‘Buzz Control’
0x02	‘Check Mode’	Check ‘Buzz Control’

<Buzz Status>

Code	Setting	Detail	Note
0x01	Buzz Off	Buzz Off	
0x02	Buzz On	Buzz On	Default

☞ Note

Doc No	KYT5XXX SPECIFICATION	REV	PAGE	DATE
9100-0020		M	39 OF 68	2007. 07. 28.

2.6 “C26” : It is to change ‘Baud Rate’.

☞ Command Format

SOH	Null	Length	STX	“C26”	DATA	ETX	Bcc
-----	------	--------	-----	-------	------	-----	-----

☞ Command Data Structure

Baud Rate
1Byte (Hex)

☞ Positive Response Format

SOH	Null	Length	STX	“C26”	GOOD	0x01	ETX	Bcc
-----	------	--------	-----	-------	------	------	-----	-----

☞ Negative Response Format

SOH	Null	Length	STX	“C26”	E-Code	0x00	ETX	Bcc
-----	------	--------	-----	-------	--------	------	-----	-----

☞ Response Data Structure

☞ Data Variable

<Baud Rate>

Code	Setting	Detail	Note
0x01	9600Bps	Set Baud Rate to be 9600Bps	
0x02	19200Bps	Set Baud Rate to be 19200Bps	
0x03	RFU		
0x04	38400Bps	Set Baud Rate to be 38400Bps	Default
0x05	57600Bps	Set Baud Rate to be 57600Bps	

Doc No	KYT5XXX SPECIFICATION	REV	PAGE	DATE
9100-0020		M	40 OF 68	2007. 07. 28.

2.7 “C27” : It is to set or to check ‘Wait Mode’.

☞ Command Format

SOH	Null	Length	STX	“C27”	DATA	ETX	Bcc
-----	------	--------	-----	-------	------	-----	-----

☞ Command Data Structure

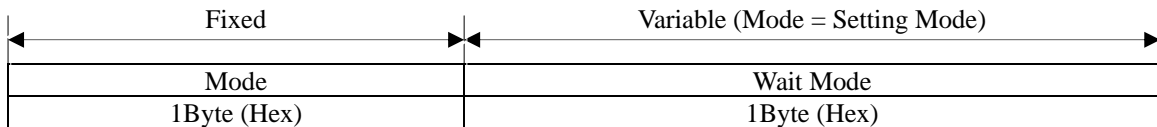

☞ Positive Response Format

SOH	Null	Length	STX	“C27”	GOOD	1	DATA	ETX	Bcc
-----	------	--------	-----	-------	------	---	------	-----	-----

☞ Negative Response Format

SOH	Null	Length	STX	“C27”	E-Code	0x00	ETX	Bcc
-----	------	--------	-----	-------	--------	------	-----	-----

☞ Response Data Structure

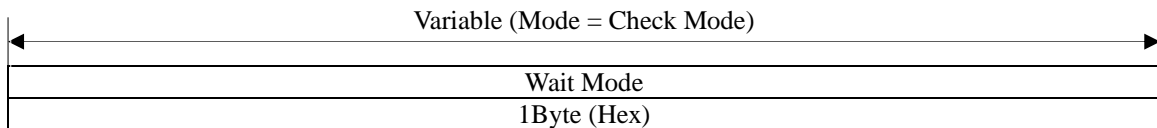

☞ Data Variable

<Mode>

Code	Mode	Detail
0x01	‘Setting Mode’	Set ‘Wait Mode’
0x02	‘Check Mode’	Check ‘Wait Mode’

<Wait Mode>

Code	Setting	Detail	Note
0x01	Normal	Set ‘Normal’	
0x02	Wait Mode	Set ‘Wait Mode’	Default

☞ Note

Accepted in the KYT530, KYT540, KYT570 series only.

Doc No	KYT5XXX SPECIFICATION	REV	PAGE	DATE
9100-0020		M	41 OF 68	2007. 07. 28.

2.8 “C28” : It is to set or to check ‘Stacker Priority’.

☞ Command Format

SOH	Null	Length	STX	“C28”	DATA	ETX	Bcc
-----	------	--------	-----	-------	------	-----	-----

☞ Command Data Structure

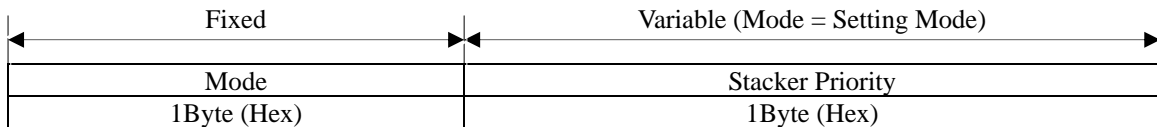

☞ Positive Response Format

SOH	Null	Length	STX	“C28”	GOOD	0x01	DATA	ETX	Bcc
-----	------	--------	-----	-------	------	------	------	-----	-----

☞ Negative Response Format

SOH	Null	Length	STX	“C28”	E-Code	0x00	ETX	Bcc
-----	------	--------	-----	-------	--------	------	-----	-----

☞ Response Data Structure

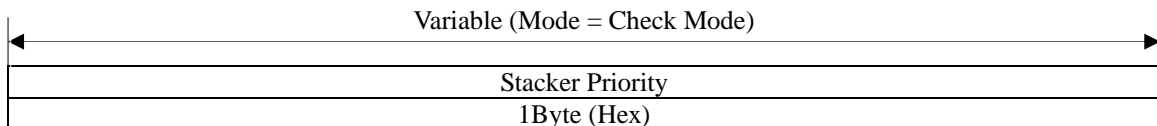

☞ Data Variable

<Mode>

Code	Mode	Detail
0x01	‘Setting Mode’	Set ‘Stacker Priority’
0x02	‘Check Mode’	Check ‘Stacker Priority’

<Stacker Priority>

Code	Setting	Detail	Note
0x01	Only Stacker 1	Set Stacker1 (Stacker2 not operational)	
0x02	Only Stacker 2	Set Stacker2 (Stacker1 not operational)	
0x03	Stacker 1	Set Stacker1(If Stacker1 is empty, operate Stacker2)	Default
0x04	Stacker 2	Set Stacker2(If Stacker2 is empty, operate Stacker1)	

☞ Note

This command affects on the terminal only in case of setting to the ‘Wait Mode’. In the wait mode, the terminal moves the card from the specified stacker to the place to wait. If no card in the stacker , it load the other card.

Doc No	KYT5XXX SPECIFICATION	REV	PAGE	DATE
9100-0020		M	42 OF 68	2007. 07. 28.

3 MOVE

3.1 “C31” : It is to take a card from Stacker and to move it to Card Reader / Writer Module.

☞ Command Format

SOH	Null	Length	STX	“C31”	DATA	ETX	Bcc
-----	------	--------	-----	-------	------	-----	-----

☞ Command Data Structure

Stacker	Module
1Byte (Hex)	1Byte (Hex)

☞ Positive Response Format

SOH	Null	Length	STX	“C31”	GOOD	0x01	ETX	Bcc
-----	------	--------	-----	-------	------	------	-----	-----

☞ Negative Response Format

SOH	Null	Length	STX	“C31”	E-Code	0x00	ETX	Bcc
-----	------	--------	-----	-------	--------	------	-----	-----

☞ Data Variable

<Stacker>

Code	Setting	Detail
0x01	Stacker 1	Select Stacker 1
0x02	Stacker 2	Select Stacker 2
0x03	Auto	Select Stacker automatically

<Module>

Code	Setting	Detail
0x01	MSRW	Card transport to MSRW Module
0x02	IC	Card transport to IC Module
0x03	RF	Card transport to RF Module

3.2 “C32” : It is take card to Card Reader / Writer Module

☞ Command Format

SOH	Null	Length	STX	“C32”	DATA	ETX	Bcc
-----	------	--------	-----	-------	------	-----	-----

☞ Command Data Structure

Module
1Byte (Hex)

☞ Positive Response Format

SOH	Null	Length	STX	“C32”	GOOD	0x01	DATA	ETX	Bcc
-----	------	--------	-----	-------	------	------	------	-----	-----

☞ Negative Response Format

SOH	Null	Length	STX	“C32”	E-Code	0x00	ETX	Bcc
-----	------	--------	-----	-------	--------	------	-----	-----

☞ Data Variable

<Module>

Code	Setting	Detail
0x01	MSRW	Card transport to MSRW Module
0x02	IC	Card transport to IC Module
0x03	RF	Card transport to RF Module

Doc No	KYT5XXX SPECIFICATION	REV	PAGE	DATE
9100-0020		M	43 OF 68	2007. 07. 28.

3.3 “C33” : It is to dispense out card to the front.

☞ Command Format

SOH	Null	Length	STX	“C33”	ETX	Bcc
-----	------	--------	-----	-------	-----	-----

☞ Positive Response Format

SOH	Null	Length	STX	“C33”	GOOD	0x01	ETX	Bcc
-----	------	--------	-----	-------	------	------	-----	-----

☞ Negative Response Format

SOH	Null	Length	STX	“C33”	E-Code	0x00	ETX	Bcc
-----	------	--------	-----	-------	--------	------	-----	-----

☞ Note

Refer to the ‘Eject Mode’ and ‘Capture Time’.

3.4 “C34” : It takes card to Bin Box (Capture)

☞ Command Format

SOH	Null	Length	STX	“C34”	ETX	Bcc
-----	------	--------	-----	-------	-----	-----

☞ Positive Response Format

SOH	Null	Length	STX	“C34”	GOOD	0x01	ETX	Bcc
-----	------	--------	-----	-------	------	------	-----	-----

☞ Negative Response Format

SOH	Null	Length	STX	“C34”	E-Code	0x00	ETX	Bcc
-----	------	--------	-----	-------	--------	------	-----	-----

☞ Details

Capture card is stored in Bin Box in the back of KYT-5X0. If the Box is full, it causes an error.

3.5 “C42” : Software RESET for Main Board

☞ Command Format

SOH	Null	Length	STX	“C42”	ETX	Bcc
-----	------	--------	-----	-------	-----	-----

☞ Positive Response Format

SOH	Null	Length	STX	“C42”	GOOD	0x01	ETX	Bcc
-----	------	--------	-----	-------	------	------	-----	-----

☞ Negative Response Format

SOH	Null	Length	STX	“C42”	E-Code	0x00	ETX	Bcc
-----	------	--------	-----	-------	--------	------	-----	-----

☞ Note

This “C42” Software RESET command is effective for KYT5000 MAIN BOARD only.

Card Dispenser and Card Reader is not RESETed.

With this software RESET, all the data setted at KYT-5000 return to DEFAULT value.

After “RESET”, minimum 5 seconds is required before running to get secure operation.

Doc No	KYT5XXX SPECIFICATION	REV	PAGE	DATE
9100-0020		M	44 OF 68	2007. 07. 28.

3.6 “C43” : Extension command

☞ Command Format

SOH	Null	Length	STX	“C43”	DATA	ETX	Bcc
-----	------	--------	-----	-------	------	-----	-----

3.6.1 Select the card Protocol or Speed & IC interface module baud rate

☞ Command Data Structure

1'st Byte	2'st Byte								REMARK	
Code	B7	B6	B5	B4	B3	B2	B1	B0		
00H	0	0	0	0	0	0	0	1	Use for ICC interface device only	
					0	0	1	0		
					0	0	1	1		
	0	0	0	1	0	0	0	1		PPS(PTS) Application Ref) ISO7916-3
					0	0	1	0		
					0	0	1	1		
2 ~ FH				Reserved for future use						
01H~FFH	Reserved for future use									

<High Nibble of 2'st Byte>

Code	Decryption
0000b	- Change the baud rate of IC Interface device. - Baud rate: Refer to following “Low Nibble of 2'st Byte” table.
00001	Value for the card to support PTS command . (Refer to ISO7816-3) - Change the baud rate of IC Interface device and IC card. - Baud rate: Refer to following “Low Nibble of 2'st Byte” table.

<Low Nibble of 2'st Byte>

Code	Decryption
0001b	9600bps
0010b	19200bps
0011b	38400bps

Doc No	KYT5XXX SPECIFICATION	REV	PAGE	DATE
9100-0020		M	45 OF 68	2007. 07. 28.

☞ Positive Response Format

SOH	Null	Length	STX	“C43”	GOOD	0x01	DATA	ETX	Bcc
-----	------	--------	-----	-------	------	------	------	-----	-----

☞ Command Data Structure

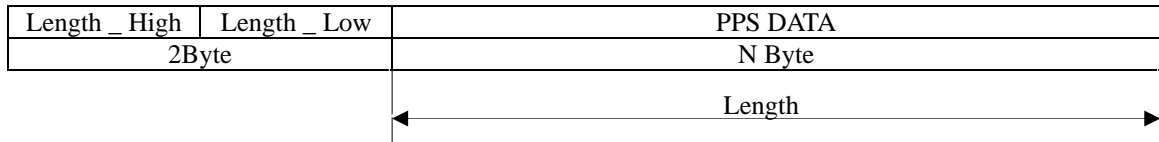

P.S)

DATA Structure: The response value of the PPS request and length of the response value.

If 4Byte(PPSS, PPS0, PPS1, PCK) is the correct value, the executing is normal.

☞ Negative Response Format

SOH	Null	Length	STX	“C43”	E-Code	0x00	ETX	Bcc
-----	------	--------	-----	-------	--------	------	-----	-----

Doc No	KYT5XXX SPECIFICATION	REV	PAGE	DATE
9100-0020		M	46 OF 68	2007. 07. 28.

◆ *MAGNETIC CARD*

This section describes the commands that can use at the magnetic card.

The data to be written in every track should be conform to the ISO7816-2 standard, the available character is as follows. For more information about Magnetic card, refer to the ISO7816-2 standard.

Track	Available Character Set	Maximum characters	REMARKS
Track #1	Character, Numbers	76	Except for the special character
Track #2	Numbers	37	
Track #3	Number	104	

The KYT5000 Series provides two features for speedy processing. The first is to provide the command combined with 'FromStacker' and 'Magnetic Write' command. This feature enables to write on card in the dispenser stacker at a command.

The second is to lessen the processing time for the 'magnetic read' command repeated after latching the data read from card. To latch data occurs at a point of time when verify in the magnetic write command and execute the magnetic read command. However, the latched data is erased when the card is off from the terminal.

The applicable models of the KYT5000 series are the KYT510, KYT520, KYT530, KYT540, the available commands set is as follows.

Item	Cm0	Cm1	Cm2	Detail	Note
MAGNETIC READ/WRITE	'M'	'3'	'1'	Magnetic card one track read	
	'M'	'3'	'3'	Magnetic card one track write	Verify
	'M'	'3'	'4'	Magnetic card write from Stacker	Verify
	'M'	'3'	'5'	Magnetic card all track read	
CLEANING	'M'	'5'	'1'	MSRW Header Cleaning	

Doc No	KYT5XXX SPECIFICATION	REV	PAGE	DATE
9100-0020		M	47 OF 68	2007. 07. 28.

Basic Magnetic Card Operations:

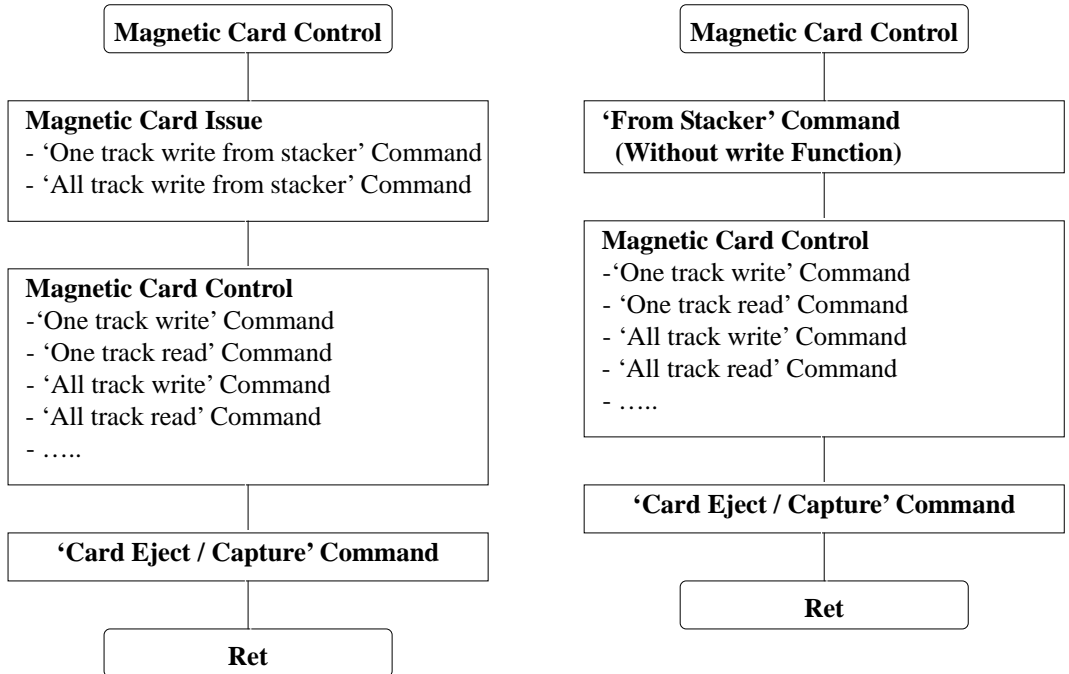

Magnetic Card Operations in the stacker

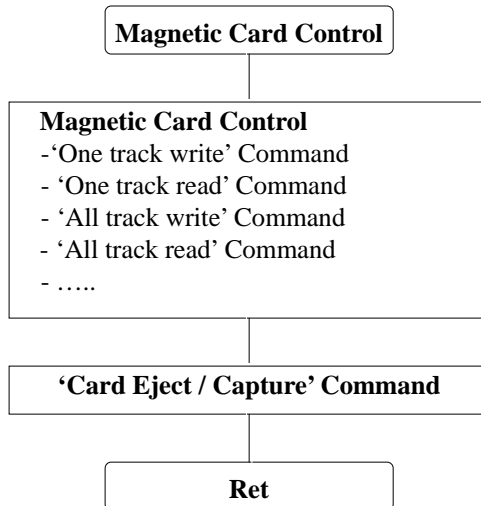

Magnetic Card Operations in the terminal

Doc No	KYT5XXX SPECIFICATION	REV	PAGE	DATE
9100-0020		M	48 OF 68	2007. 07. 28.

1 MAGNETIC READ / WRITE

1.1 “M31” : It is to read data on track chosen.

Command Format

SOH	Null	Length	STX	“M31”	DATA	ETX	Bcc
-----	------	--------	-----	-------	------	-----	-----

Command Data Structure

Track (1Byte)

Positive Response Format

SOH	Null	Length	STX	“M31”	GOOD	0x01	DATA	ETX	Bcc
-----	------	--------	-----	-------	------	------	------	-----	-----

Negative Response Format

SOH	Null	Length	STX	“M31”	E-Code	0x00	ETX	Bcc
-----	------	--------	-----	-------	--------	------	-----	-----

Response Data Structure

Read Data (ASCII Code)

Data Variable

<Track>

Code	Setting	Detail
0x01	Track 1	Read data on Track 1
0x02	Track 2	Read data on Track 2
0x03	Track 3	Read data on Track 3

Note

If the ‘Magnetic Read’ command is executed normally, the read data is latched.

1.2 “M33” : It is to write data on track chosen.

Command Format

SOH	Null	Length	STX	“M33”	DATA	ETX	Bcc
-----	------	--------	-----	-------	------	-----	-----

Command Data Structure

Track	Write Data
1Byte (Hex)	(ASCII Code)

Positive Response Format

SOH	Null	Length	STX	“M33”	GOOD	0x01	ETX	Bcc
-----	------	--------	-----	-------	------	------	-----	-----

Negative Response Format

SOH	Null	Length	STX	“M33”	E-Code	0x00	ETX	Bcc
-----	------	--------	-----	-------	--------	------	-----	-----

Data Variable

<Track>

Code	Setting	Detail
0x01	Track 1	Write data to Track 1
0x02	Track 2	Write data to Track 2
0x03	Track 3	Write data to Track 3

Note

If the ‘Magnetic Write’ command is executed normally, the written data is latched. This command has the ‘Verify’ feature.

Doc No	KYT5XXX SPECIFICATION	REV	PAGE	DATE
9100-0020		M	49 OF 68	2007. 07. 28.

1.3 “M34” : It is to take a card from Stacker and to write data to a selected track.

☞ Command Format

SOH	Null	Length	STX	“M34”	DATA	ETX	Bcc
-----	------	--------	-----	-------	------	-----	-----

☞ Command Data Structure

Stacker	Track	Write Data
1Byte (Hex)	1Byte (Hex)	(ASCII Code)

☞ Positive Response Format

SOH	Null	Length	STX	“M34”	GOOD	0x01	ETX	Bcc
-----	------	--------	-----	-------	------	------	-----	-----

☞ Negative Response Format

SOH	Null	Length	STX	“M34”	E-Code	0x00	ETX	Bcc
-----	------	--------	-----	-------	--------	------	-----	-----

☞ Data Variable

<Stacker>

Code	Setting	Detail
0x01	Stacker 1	Select Stacker 1
0x02	Stacker 2	Select Stacker 2
0x02	Auto	Select Stacker automatically

<Track>

Code	Setting	Detail
0x01	Track 1	Write data to Track 1
0x02	Track 2	Write data to Track 2
0x03	Track 3	Write data to Track 3

☞ Note

This command has the Data ‘Latch ‘and ‘Verify’ features.

1.4 “M35” : It is to read data from all three tracks.

☞ Command Format

SOH	Null	Length	STX	“M35”	ETX	Bcc
-----	------	--------	-----	-------	-----	-----

☞ Positive Response Format

SOH	Null	Length	STX	“M35”	GOOD	0x01	DATA	ETX	Bcc
-----	------	--------	-----	-------	------	------	------	-----	-----

☞ Negative Response Format

SOH	Null	Length	STX	“M35”	E-Code	0x00	ETX	Bcc
-----	------	--------	-----	-------	--------	------	-----	-----

☞ Response Data Structure

0x01	Track1 Data	0x02	Track2 Data	0x03	Track3 Data
1Byte (Hex)	(ASCII)	1Byte (Hex)	(ASCII)	1Byte (Hex)	(ASCII)

☞ Note

If the ‘Magnetic Read’ command is executed normally, the read data is latched.

Doc No	KYT5XXX SPECIFICATION	REV	PAGE	DATE
9100-0020		M	50 OF 68	2007. 07. 28.

2 CLEANING

2.1 “M51” : It is to clean Magnetic Head mounted inside MSRW.

☞ Command Format

SOH	Null	Length	STX	“M51”	ETX	Bcc
-----	------	--------	-----	-------	-----	-----

☞ Positive Response Format

SOH	Null	Length	STX	“M51”	GOOD	0x01	ETX	Bcc
-----	------	--------	-----	-------	------	------	-----	-----

☞ Negative Response Format

SOH	Null	Length	STX	“M51”	E-Code	0x00	ETX	Bcc
-----	------	--------	-----	-------	--------	------	-----	-----

Doc No	KYT5XXX SPECIFICATION	REV	PAGE	DATE
9100-0020		M	51 OF 68	2007. 07. 28.

◆ **IC CARD**

This section describes the commands that can use at the IC card and Memory card.

The IC card should conform to the ISO7816-4 T=0 and T=1 , these cards is available

The applicable models in the KYT5000 Series are the KYT520, KYT540, KYT550, KYT570, and the available commands are as follows.

Item	Cm0	Cm1	Cm2	Detail	Note
IC CONTROL	'T'	'2'	'1'	IC Card Reset	
	'T'	'2'	'2'	IC Card Direct Control	
	'C'	'4'	'3'	Ref) Section 3.6.1	

Select the card Protocol or Speed & IC module baud rate

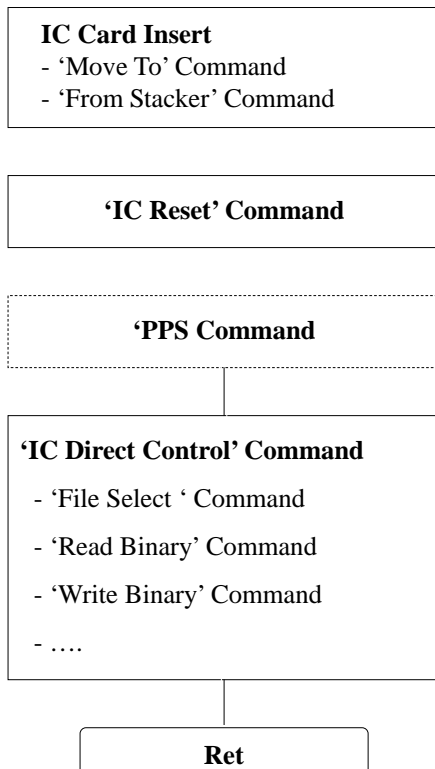

Option :.you can select use or not use according to necessity
Ref) Section 3.6.1(page 38)

Doc No	KYT5XXX SPECIFICATION	REV	PAGE	DATE
9100-0020		M	52 OF 68	2007. 07. 28.

1 IC CONTROL

1.1 "I21" : Reset the IC card and receive the ATR from card.

Command Format

SOH	Null	Length	STX	"I21"	ETX	Bcc
-----	------	--------	-----	-------	-----	-----

Positive Response Format

SOH	Null	Length	STX	"I21"	GOOD	0x01	DATA	ETX	Bcc
-----	------	--------	-----	-------	------	------	------	-----	-----

Negative Response Format

SOH	Null	Length	STX	"I21"	E-Code	0x00	ETX	Bcc
-----	------	--------	-----	-------	--------	------	-----	-----

Response Data Structure

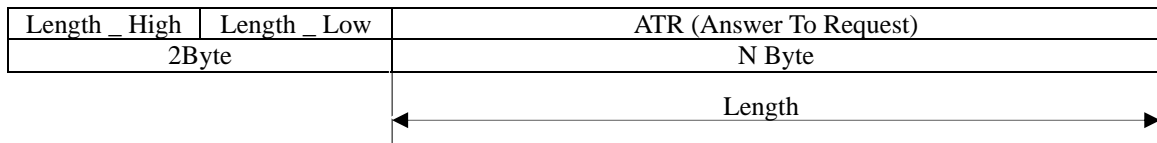

Example

SAMSUNG SCOS ATR

High 8Byte	0x3B	0x6B	0x00	0x00	0x80	0x31	0x80	0x63
Low 7Byte	0x53	0x46	0x01	0x83	0x03	0x90	0x00	

1.2 "I22" : Control the card conforming to the ISO 7816 T = 0 and T =1 , ISO 7816 – 4 standard directly.

Command Format

SOH	Null	Length	STX	"I22"	DATA	ETX	Bcc
-----	------	--------	-----	-------	------	-----	-----

Command Data Structure

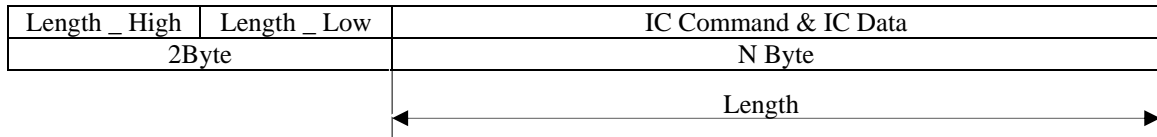

Positive Response Format

SOH	Null	Length	STX	"I22"	GOOD	0x01	DATA	ETX	Bcc
-----	------	--------	-----	-------	------	------	------	-----	-----

Negative Response Format

SOH	Null	Length	STX	"I22"	E-Code	0x00	ETX	Bcc
-----	------	--------	-----	-------	--------	------	-----	-----

Response Data Structure

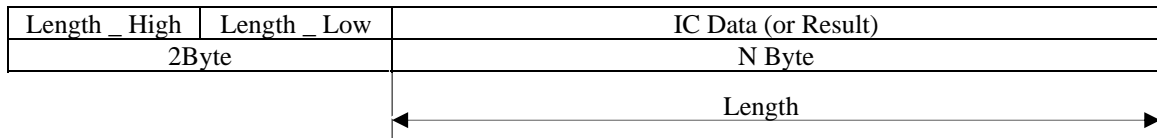

Doc No	KYT5XXX SPECIFICATION	REV	PAGE	DATE
9100-0020		M	53 OF 68	2007. 07. 28.

IC Command & IC Data Structure

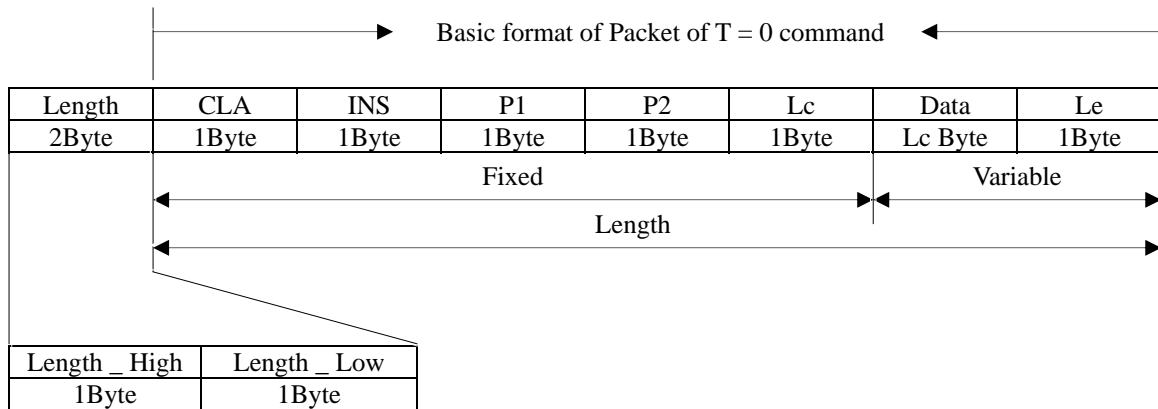

CLA	Class	Note
INS	Instruction	
P1	Offset(High Value)	
P2	Offset(Low Value)	
Lc	A number of data to transfer	Max Value : 255
Data	Data to Transfer	
Le	A number of data to receive	

Format of T = 0 Command

Command	INS Code (Hex Value)
Read Binary Command	B0
Write Binary Command	D0
Update Binary Command	D6
Erase Binary Command	0E
Read Record(s) Command	B2
Write Record Command	D2
Append Record Command	E2
Update Record Command	DC
Get Data Command	CA
Put Data Command	DA
Select File Command	A4
Verify Command	20
Internal Authenticate Command	88
External Authenticate Command	82
Get Challenge Command	84
Manage Channel Command	70

For more information, refer to the ISO 7816 – 4 standard.

Doc No	KYT5XXX SPECIFICATION	REV	PAGE	DATE
9100-0020		M	54 OF 68	2007. 07. 28.

◆ *RF CARD*

This section describes the commands that can use at the 'RF CARD'.

The RF Module of his model supports only the MIFARE card.

The applicable models of the KYT5000 Series are the KYT540, KYT560, KYT570, the available commands are as follows.

Item	Cm0	Cm1	Cm2	Detail	Note
RF CARD READ /WRITE	'R'	'3'	'1'	Read RF card data in block range	
	'R'	'3'	'2'	Write RF card in block range	
	'R'	'3'	'6'	Read RF card in sector range	
	'R'	'3'	'7'	Write RF card in sector range	
BALANCE	'R'	'4'	'1'	Increment balance in RF card	
	'R'	'4'	'2'	Decrement balance in RF card	
CHANGE SECRET KEY	'R'	'5'	'1'	Change 'Secret Key' to other key	
	'R'	'5'	'2'	Change 'Secret Key' to all the same Key Value	
	'R'	'5'	'3'	Select 'Secret Key Index'	
	'R'	'5'	'4'	Change RF Card 'Secret Key' to other key	
RF DETECT	'R'	'6'	'1'	Check RF card in antenna area	

To use the RF card, you need to initialize at first.

- Setting and updating of the secret key and secret key index.

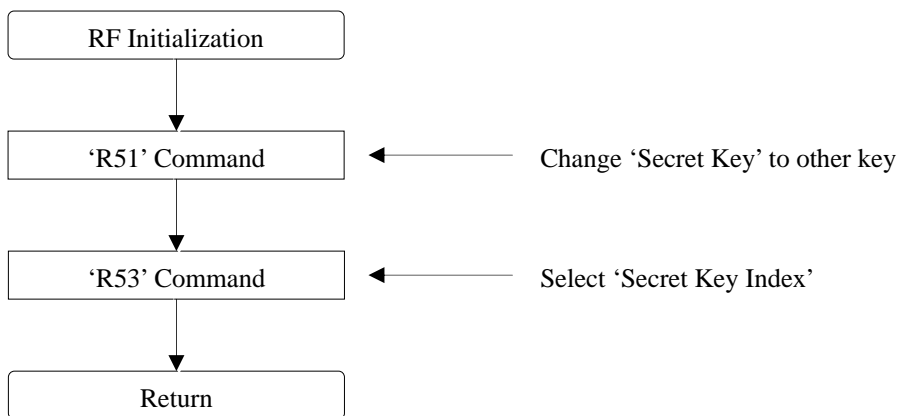

RF Module Initialization

Doc No	KYT5XXX SPECIFICATION	REV	PAGE	DATE
9100-0020		M	55 OF 68	2007. 07. 28.

Basic Operating Procedure of the RF card:

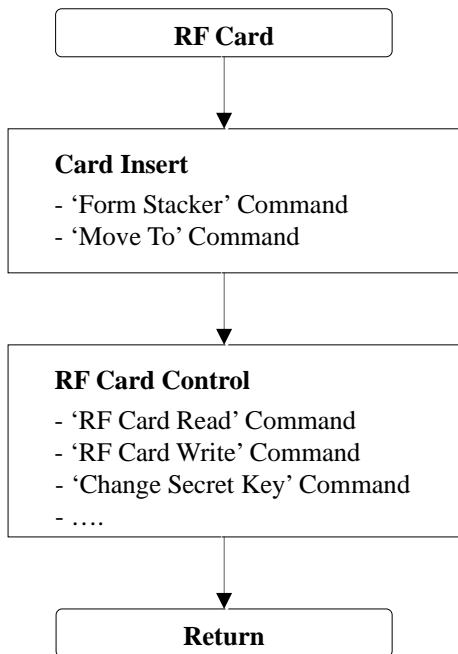

RF Card Basic Operating Procedures

Memory Architecture(map) of the RF card: 8Kbit

Sector	Block	Size	Detail	Note
Sector 0	Block 0	16Byte	RF Card Information	Can't use
	Block 1	16Byte		
	Block 2	16Byte		
	Block 3	16Byte	'Sector Key'	
Sector 1	Block 0	16Byte	User Available Memory	
	Block 1	16Byte		
	Block 2	16Byte		
	Block 3	16Byte	'Sector Key'	
Sector 2	Block 0	16Byte	User Available Memory	
	Block 1	16Byte		
	Block 2	16Byte		
	Block 3	16Byte	'Sector Key'	
---	---	---	---	---
Sector 15	Block 0	16Byte	User Available Memory	
	Block 1	16Byte		
	Block 2	16Byte		
	Block 3	16Byte	'Sector Key'	

Doc No	KYT5XXX SPECIFICATION	REV	PAGE	DATE
9100-0020		M	56 OF 68	2007. 07. 28.

1 RF CARD READ / WRITE

1.1 "R31" : Read RF card data & Secret Key in block range

☞ Command Format

SOH	Null	Length	STX	"R31"	DATA	ETX	Bcc
-----	------	--------	-----	-------	------	-----	-----

☞ Command Data Structure

Sector	Block
0x00 – 0x0f	0x00 – 0x03
1Byte (Hex)	1Byte (Hex)

☞ Positive Response Format

SOH	Null	Length	STX	"R31"	GOOD	0x01	DATA	ETX	Bcc
-----	------	--------	-----	-------	------	------	------	-----	-----

☞ Negative Response Format

SOH	Null	Length	STX	"R31"	E-Code	0x00	ETX	Bcc
-----	------	--------	-----	-------	--------	------	-----	-----

☞ Response Data Structure

Sector	Block	Read Data
1Byte (Hex)	1Byte (Hex)	16 Byte (Hex)

D0	D1	D2	---	D14	D15
1Byte	1Byte	1Byte	---	1Byte	1Byte

1.2 "R32" : Write RF card data in block range

☞ Command Format

SOH	Null	Length	STX	"R32"	DATA	ETX	Bcc
-----	------	--------	-----	-------	------	-----	-----

☞ Command Data Structure

Sector	Block	Write Data
0x00 – 0x0f	0x00 – 0x02	0x00 – 0xff
1Byte (Hex)	1Byte (Hex)	16Byte (Hex)

D0	D1	D2	---	D14	D15
1Byte	1Byte	1Byte	---	1Byte	1Byte

☞ Positive Response Format

SOH	Null	Length	STX	"R32"	GOOD	0x01	ETX	Bcc
-----	------	--------	-----	-------	------	------	-----	-----

☞ Negative Response Format

SOH	Null	Length	STX	"R32"	E-Code	0x00	ETX	Bcc
-----	------	--------	-----	-------	--------	------	-----	-----

Doc No	KYT5XXX SPECIFICATION	REV	PAGE	DATE
9100-0020		M	57 OF 68	2007. 07. 28.

1.3 “R36” : Read RF card data in sector range

☞ Command Format

SOH	Null	Length	STX	“R36”	DATA	ETX	Bcc
-----	------	--------	-----	-------	------	-----	-----

☞ Command Data Structure

Sector
0x00 – 0x0f
1Byte (Hex)

☞ Positive Response Format

SOH	Null	Length	STX	“R36”	GOOD	0x01	DATA	ETX	Bcc
-----	------	--------	-----	-------	------	------	------	-----	-----

☞ Negative Response Format

SOH	Null	Length	STX	“R36”	E-Code	0x00	ETX	Bcc
-----	------	--------	-----	-------	--------	------	-----	-----

☞ Response Data Structure

0x00	Read Data (0)	0x01	Read Data (1)	0x02	Read Data (2)
1Byte (Hex)	16Byte (Hex)	1Byte (Hex)	16Byte (Hex)	1Byte (Hex)	16Byte (Hex)

D0	D1	D2	---	D14	D15
1Byte	1Byte	1Byte	---	1Byte	1Byte

1.4 “R37” : Write RF card data in sector range (except Sector 0)

☞ Command Format

SOH	Null	Length	STX	“R37”	DATA	ETX	Bcc
-----	------	--------	-----	-------	------	-----	-----

☞ Command Data Structure

Sector	Write Data
0x01 – 0x0f	0x00 – 0xff
1Byte (Hex)	51Byte (Hex)

0x00	Read Data (0)	0x01	Read Data (1)	0x02	Read Data (2)
1Byte (Hex)	16Byte (Hex)	1Byte (Hex)	16Byte (Hex)	1Byte (Hex)	16Byte (Hex)

D0	D1	D2	---	D14	D15
1Byte	1Byte	1Byte	---	1Byte	1Byte

☞ Positive Response Format

SOH	Null	Length	STX	“R37”	GOOD	0x01	ETX	Bcc
-----	------	--------	-----	-------	------	------	-----	-----

☞ Negative Response Format

SOH	Null	Length	STX	“R37”	E-Code	0x00	ETX	Bcc
-----	------	--------	-----	-------	--------	------	-----	-----

Doc No	KYT5XXX SPECIFICATION	REV	PAGE	DATE
9100-0020		M	58 OF 68	2007. 07. 28.

2 BALANCE

2.1 “R41” : Increment the balance of card to the specified amount.

☞ Command Format

SOH	Null	Length	STX	“R41”	DATA	ETX	Bcc
-----	------	--------	-----	-------	------	-----	-----

☞ Command Data Structure

Sector	Block	Index Value
0x00 – 0x0f	0x00 – 0x02	0x00000000 – 0xffffffff
1Byte (Hex)	1Byte (Hex)	4Byte (Hex)

V0	V1	V2	V3
0x00-0xff	0x00-0xff	0x00-0xff	0x00-0xff
1Byte(Hex, LSB)	1Byte(Hex)	1Byte(Hex)	1Byte(Hex, MSB)

☞ Positive Response Format

SOH	Null	Length	STX	“R41”	GOOD	0x01	ETX	Bcc
-----	------	--------	-----	-------	------	------	-----	-----

☞ Negative Response Format

SOH	Null	Length	STX	“R41”	E-Code	0x00	ETX	Bcc
-----	------	--------	-----	-------	--------	------	-----	-----

☞ Note

The balance should be written in the Electronic Purse format in the card.

2.1 “R42” : Decrement the balance of card to the specified amount..

☞ Command Format

SOH	Null	Length	STX	“R42”	DATA	ETX	Bcc
-----	------	--------	-----	-------	------	-----	-----

☞ Command Data Structure

Sector	Block	Index Value
0x00 – 0x0f	0x00 – 0x02	0x00000000 – 0xffffffff
1Byte (Hex)	1Byte (Hex)	4Byte (Hex)

V0	V1	V2	V3
0x00-0xff	0x00-0xff	0x00-0xff	0x00-0xff
1Byte(Hex, LSB)	1Byte(Hex)	1Byte(Hex)	1Byte(Hex, MSB)

☞ Positive Response Format

SOH	Null	Length	STX	“R42”	GOOD	0x01	ETX	Bcc
-----	------	--------	-----	-------	------	------	-----	-----

☞ Negative Response Format

SOH	Null	Length	STX	“R42”	E-Code	0x00	ETX	Bcc
-----	------	--------	-----	-------	--------	------	-----	-----

☞ Note

The balance should be written in the Electronic Purse format in the card.

Doc No	KYT5XXX SPECIFICATION	REV	PAGE	DATE
9100-0020		M	59 OF 68	2007. 07. 28.

3 SECRET KEY

3.1 “R51” : Change ‘Secret Key’ to a new key

☞ Command Format

SOH	Null	Length	STX	“R51”	DATA	ETX	Bcc
-----	------	--------	-----	-------	------	-----	-----

☞ Command Data Structure

Sector	KEY A	KEY B
0x00 – 0x0f	0x00 – 0xff	0x00 – 0xff
1Byte (Hex)	6Byte (Hex)	6Byte (Hex)

☞ Positive Response Format

SOH	Null	Length	STX	“R51”	GOOD	0x01	ETX	Bcc
-----	------	--------	-----	-------	------	------	-----	-----

☞ Negative Response Format

SOH	Null	Length	STX	“R51”	E-Code	0x00	ETX	Bcc
-----	------	--------	-----	-------	--------	------	-----	-----

☞ Note

KYT-5000 Series ‘Secret Key’ Default – Key Set 0

KEY A : FFFFFFFFFF

KEY B : FFFFFFFFFF

3.2 “R52” : Change ‘Secret Key’ to all the same key value

☞ Command Format

SOH	Null	Length	STX	“R52”	DATA	ETX	Bcc
-----	------	--------	-----	-------	------	-----	-----

☞ Command Data Structure

KEY A	KEY B
0x00 – 0xff	0x00 – 0xff
6Byte (Hex)	6Byte (Hex)

☞ Positive Response Format

SOH	Null	Length	STX	“R52”	GOOD	0x01	ETX	Bcc
-----	------	--------	-----	-------	------	------	-----	-----

☞ Negative Response Format

SOH	Null	Length	STX	“R52”	E-Code	0x00	ETX	Bcc
-----	------	--------	-----	-------	--------	------	-----	-----

☞ Note

KYT-5000 Series ‘Secret Key’ Default – Key Set 0

KEY A : FFFFFFFFFF

KEY B : FFFFFFFFFF

Doc No	KYT5XXX SPECIFICATION	REV	PAGE	DATE
9100-0020		M	60 OF 68	2007. 07. 28.

3.3 “R53” : Select ‘Secret Key Index’

☞ Command Format

SOH	Null	Length	STX	“R53”	DATA	ETX	Bcc
-----	------	--------	-----	-------	------	-----	-----

☞ Command Data Structure

Index
0x01 – 0x02
1Byte (Hex)

☞ Positive Response Format

SOH	Null	Length	STX	“R53”	GOOD	0x01	ETX	Bcc
-----	------	--------	-----	-------	------	------	-----	-----

☞ Negative Response Format

SOH	Null	Length	STX	“R53”	E-Code	0x00	ETX	Bcc
-----	------	--------	-----	-------	--------	------	-----	-----

☞ Data Variable

<Index>

Code	Setting	Detail
0x01	KEY A	Select ‘Secret Key A’
0x02	KEY B	Select ‘Secret Key B’

☞ Note

KYT-5000 Series ‘Secret Key Index’ Default

‘Secret Key Index ‘ : KEY A

3.4 “R54” : Change RF card ‘Secret Key’ to other key

☞ Command Format

SOH	Null	Length	STX	“R54”	DATA	ETX	Bcc
-----	------	--------	-----	-------	------	-----	-----

☞ Command Data Structure

- Command data structure without ‘Access Condition’

Sector	KEY A	KEY B
0x00 – 0x0f	0x00 – 0xff	0x00 – 0xff
1Byte (Hex)	6Byte (Hex)	6Byte (Hex)

- Command data structure with ‘Access Condition’

Sector	KEY A	Access	KEY B
0x00 – 0x0f	0x00 – 0xff	0x00 – 0xff	0x00 – 0xff
1Byte (Hex)	6Byte (Hex)	4Byte (Hex)	6Byte (Hex)

☞ Positive Response Format

SOH	Null	Length	STX	“R54”	GOOD	0x01	ETX	Bcc
-----	------	--------	-----	-------	------	------	-----	-----

☞ Negative Response Format

SOH	Null	Length	STX	“R54”	E-Code	0x00	ETX	Bcc
-----	------	--------	-----	-------	--------	------	-----	-----

☞ Warning

If you use this command incorrectly, it couldn’t be authenticated from the card.

Doc No	KYT5XXX SPECIFICATION	REV	PAGE	DATE
9100-0020		M	61 OF 68	2007. 07. 28.

3.5 “R55” : Change ‘Secret Key’ to a new key from Key Set Number.

☞ Command Format

SOH	Null	Length	STX	“R51”	DATA	ETX	Bcc
-----	------	--------	-----	-------	------	-----	-----

☞ Command Data Structure

Key Set	Sector	KEY A	KEY B
0x00 – 0x02	0x00 – 0x0f	0x00 – 0xff	0x00 – 0xff
1 Byte(Hex)	1Byte (Hex)	6Byte (Hex)	6Byte (Hex)

☞ Positive Response Format

SOH	Null	Length	STX	“R51”	GOOD	0x01	ETX	Bcc
-----	------	--------	-----	-------	------	------	-----	-----

☞ Negative Response Format

SOH	Null	Length	STX	“R51”	E-Code	0x00	ETX	Bcc
-----	------	--------	-----	-------	--------	------	-----	-----

☞ Note

Key Set <Index>

Code	Detail
0x00	Key Set 0
0x01	Key Set 1
0x02	Key Set 2

3.6 “R56” : Change ‘Secret Key’ to all the same key value from Key Set Number.

☞ Command Format

SOH	Null	Length	STX	“R52”	DATA	ETX	Bcc
-----	------	--------	-----	-------	------	-----	-----

☞ Command Data Structure

Key Set	KEY A	KEY B
0x00 – 0x02	0x00 – 0xff	0x00 – 0xff
1 Byte(Hex)	6Byte (Hex)	6Byte (Hex)

☞ Positive Response Format

SOH	Null	Length	STX	“R52”	GOOD	0x01	ETX	Bcc
-----	------	--------	-----	-------	------	------	-----	-----

☞ Negative Response Format

SOH	Null	Length	STX	“R52”	E-Code	0x00	ETX	Bcc
-----	------	--------	-----	-------	--------	------	-----	-----

☞ Note

Key Set <Index>

Code	Detail
0x00	Key Set 0
0x01	Key Set 1
0x02	Key Set 2

Doc No	KYT5XXX SPECIFICATION	REV	PAGE	DATE
9100-0020		M	62 OF 68	2007. 07. 28.

4 RF DETECT

4.1 "R61" : RF card detect in antenna area

☞ Command Format

SOH	Null	Length	STX	"R61"	ETX	Bcc
-----	------	--------	-----	-------	-----	-----

☞ Positive Response Format

SOH	Null	Length	STX	"R61"	GOOD	DATA	0x01	ETX	Bcc
-----	------	--------	-----	-------	------	------	------	-----	-----

☞ Negative Response Format

SOH	Null	Length	STX	"R61"	E-Code	0x00	ETX	Bcc
-----	------	--------	-----	-------	--------	------	-----	-----

☞ Response Data Structure

Serial Number
Hex Code
4Byte

☞ Note

If the RF card is detected, this command send the serial number to host. But, it doesn't authenticate the Secret Key of the RF card.

Doc No	KYT5XXX SPECIFICATION	REV	PAGE	DATE
9100-0020		M	63 OF 68	2007. 07. 28.

ERROR DETAIL

<GOOD>

Code : 0x0000

Description: Normal Execution

Procedures: None

<NOT_DEFINE_COMMAND>

Code : 0x2001

Description : Using the command that does not defined in this model.

Action : Use the valid command in this model.

<NOT_USE_COMMAND>

Code : 0x2002

Description : Not available command in this model.

Action : Use the valid command in this model.

<COMM_FRAME_ERROR>

Code : 0x2003

Description : Sending the command that has the invalid communication frame.

Action : Check the data format and the corresponding module specification.

<CARD_JAM>

Code : 0x2004

Description : When the card is jammed.

Action : Remove the jammed card.

<NO_CARD>

Code : 0x2005

Description : No cards.

Action : Insert the card.

Doc No	KYT5XXX SPECIFICATION	REV	PAGE	DATE
9100-0020		M	64 OF 68	2007. 07. 28.

<CARD_PRESENT>

Code : 0x2006

Description : When the card exists already in the terminal.

Action : Eject the card.

<BUSY>

Code : 0x2007

Description : When the terminal is running or busy.

Action : Wait until the previous operation is completed.

<RTC_ERROR>

Code : 0x2008

Description : When the RTC chip is broken.

Action : Replace the board.

<TWO_CART_ERROR>

Code : 0x2009

Description : When more than one card is presented in the feeder part.

Action : Remove one card.

<DISPENSER_ERROR>

Code : 0x2100

Description : Not Applicable Dispenser.

Action : Reset the terminal and exchange the dispenser..

<DISPENSER_COMM_ERROR>

Code : 0x2101

Description : Dispenser communication error

Action : Check the communication line and reset the terminal.

<STACKER1_ERROR>

Code : 0x2102

Description : The first STACKER ERROR

Action : Be sure that the card is loaded at the first stacker.

Doc No	KYT5XXX SPECIFICATION	REV	PAGE	DATE
9100-0020		M	65 OF 68	2007. 07. 28.

<STACKER2_ERROR>

Code : 0x2103

Description: The second STACKER ERROR

Action : Be sure that the card is loaded at the second stacker.

<ALL_EMPTY>

Code : 0x2104

Description : No cards at both the first and second stacker.

Action : Load the card in the stacker.

<STACKER1_EMPTY>

Code : 0x2105

Description : No card at the first stacker.

Action : Load the card at the first stacker.

<STACKER2_EMPTY>

Code : 0x2106

Description : No card at the second stacker.

Action : Load the card at the second stacker.

<STACKER1_WARNING>

Code : 0x2107

Description : Too few cards in the first stacker.

Action : Load the card at the first stacker.

<STACKER2_WARNING>

Code : 0x2108

Description : Too few cards in the second stacker.

Action : Load the card at the second stacker.

<ERROR_BIN_FULL>

Code : 0x2109

Description : Too many cards in the 'CAPTURE BOX'.

Action : Keep the capture box empty.

Doc No	KYT5XXX SPECIFICATION	REV	PAGE	DATE
9100-0020		M	66 OF 68	2007. 07. 28.

<MSRW_ERROR>

Code : 0x2200

Description : The MS Reader/Writer that cannot use in this model.

Action : Change the MS Reader/Writer.

<MSRW_COMM_ERROR>

Code : 0x2201

Description : The MS Reader/Writer communication error.

Action : Check the communication line and reset the terminal.

<MSRW_WRITE_ERROR>

Code : 0x2202

Description : Error when the MS Reader/Writer is writing on the card.

Action : Clean the header and check the card.

<MSRW_READ_ERROR>

Code : 0x2203

Description : Error when the MS Reader/Writer is reading on the card.

Action : Clean the header and check the card.

<IC_CONTACT_ERROR>

Code : 0x2204

Description : Error while the terminal contacts the IC card.

Action : Be sure that the current card is an IC card.

<IC_CONTROL_ERROR>

Code : 0x2205

Description : Error while the terminal executes the IC card command.

Action : Check if the command is able to use in the contacted card.

<RF_ERROR>

Code : 0x2300

Description : Unavailable RF module.

Action : Change the RF MODULE

Doc No	KYT5XXX SPECIFICATION	REV	PAGE	DATE
9100-0020		M	67 OF 68	2007. 07. 28.

<RF_COMM_ERROR>

Code : 0x2301

Description : Communication error at the RF Module.

Action : Check the connection socket

<RF_AUTHEN_ERROR>

Code : 0x2302

Description : Authentication Error at the RF Module.

Action : Change the 'SECRET KEY'

<RF_WRITE_ERROR>

Code : 0x2303

Description : Error while the terminal writes at the RF Card.

Action : Be sure that the card exists in the detection range.

<RF_READ_ERROR>

Code : 0x2304

Description : Error while the terminal reads at the RF Card.

Action: Be sure that the card exists in the detection range.

<RF_DETECT_ERROR>

Error Code : 0x2305

Description : No RF Card.

Action : Insert the RF Card into the terminal.

<RF_AMOUNT_ERROR>

Error Code : 0x2306

Description : Error while the terminal increases(or decreases) the balance at the RF card.

Action : Tune the RF module.

Doc No	KYT5XXX SPECIFICATION	REV	PAGE	DATE
9100-0020		M	68 OF 68	2007. 07. 28.

Precautions

1. Check if the card exists in stacker. Otherwise, it may not issue the card.

2. Check the communication line

1) Communication Port, Baud, Parity, and Data Bit, etc.

3. Check the 'CAPTURE BOX'.

The 'BIN FULL' error might be caused, if you turn on the power in condition that the card exists in the 'CAPTURE BOX' behind the terminal.